

L100-1F/L300-1F/L600-1F L100-1FS/L300-1FS/L600-1FS Product Instructions



Contents

Contents.....	2
1 General Information.....	6
1.1 Precaution	6
1.2 Warranty and Service	6
1.2.1 Warranty commitment.....	6
1.2.2 Commitment for maintenance	7
1.2.3 Dispute settlement	7
1.3 Notes for product repair	7
1.4 Contact information.....	8
2 Product Introduction	9
2.1 Main Features.....	9
2.2 Unpacking.....	9
2.3 Product System Structure	9
2.3.1 Pump Drive	10
2.3.2 Applicable Pump Head and Tubing, and Reference Flow Rate	13
2.4 Function & Specification	16
3 System Installation	20
3.1 Outline Dimensions.....	20
3.2 Installation of Pump Head.....	20
3.2.1 Installation of Pump Head YZ1515x/YZ2515x/YZII15/YZII25	20
3.2.2 Installation of Pump Head FG15-13/FG25-13	21
3.2.3 Installation of Pump Head DMD15-13 and Tubing	22
3.2.4 Installation of Pump Head BZ15-13/BZ25-13	23
3.2.5 Installation of Pump Head DG15-24/DG15-28	23
3.2.6 Installation of Pump Head DG Series.....	24
4 Operation	24
4.1 Pretreatment.....	25
4.2 Standby Screen	25
4.3 Method Programming	27

4.3.1 Method Selection	27
4.3.1.1 Confirmation of pump head and tubing	29
4.3.2 Method Configuration.....	29
4.3.2.1 Selection Screens for Pump Head and Tubing	30
4.3.2.2 Setting Screen of Fluid Coefficient and Fluid Density	31
4.3.3 Method Editing.....	32
4.3.3.1 Modification of Method Name.....	32
4.3.3.2 Modular Programming	33
4.3.3.3 Enabling and Disabling of Method Steps	34
4.3.4 Module Parameter Setting	35
4.3.4.1 Parameter Setting of Constant Speed Module.....	36
4.3.4.2 Parameter Setting of Ramp Up Module	37
4.3.4.3 Parameter Setting of Ramp Down Module.....	38
4.3.4.4 Parameter Setting of Stepped Up Module.....	39
4.3.4.5 Parameter Setting of Stepped Down Module	40
4.3.4.6 Parameter Setting of Constant Dispensing Module	41
4.3.4.7 Parameter Setting of Incremental Dispensing Module.....	42
4.3.4.8 Parameter Setting of Decremental Dispensing Module	43
4.3.4.9 Parameter Setting of Sine Curve Module	44
4.3.4.10 Parameter Setting of Direction Module	45
4.3.4.11 Parameter Setting of Pause Module.....	46
4.3.4.12 Parameter Setting of Delay Module.....	47
4.3.4.13 Parameter Setting of Event Trigger Module	48
4.3.4.14 Parameter Setting of External Output Module.....	49
4.3.4.15 Parameter Setting of Jump Module	50
4.3.4.16 Parameter Setting of Loop Module.....	51
4.3.4.17 Parameter Setting of End Module	51
4.4 Calibration	51
4.4.1 Volume Calibration.....	52
4.4.2 Weighing Calibration	55
4.5 System Parameter Settings	56
4.5.1 Foot Switch Setting	57
4.5.2 Communication Setting	58
4.5.3 External Control Setting	58

4.5.4 Language Setting.....	59
4.5.5 Factory Reset	60
4.5.6 Product Information.....	61
5 External Control	62
5.1 Communication Control	63
5.1.1 RS485 Communication (Interface 1, Interface 2)	63
5.1.2 USB Communication (Interface 4).....	63
5.1.3 MODBUS RTU Protocol.....	64
5.1.4 Pump Head Definition in the MODBUS RTU Protocol.....	66
5.1.5 Tubing Definition in the MODBUS RTU Protocol.....	67
5.2 Foot Switch Control (Interface 3).....	68
5.3 External Signal Control	68
5.4 Definition of External Control Input Interface (Interface 5).....	70
5.5 Definition of External Control Output Interface (Interface 6)	74
6 RFID Identification of Pump Head and Tubing.....	74
6.1 Automatic Identification of Pump Head	75
6.2 Automatic Identification of Tubing	75
7 Appendix	78
Table 1: Applicable Pump Head and Tubing, and Reference Flow Rate	78
Table 2: Function & Specification.....	80
Table 3: External Control Functions.....	84
Table 4: Foot Switch Control Function	85
Table 5: External Control Programming Functions.....	85
Table 6: Modbus RTU Protocol.....	86
Table 6.1: Pump Head Definition in Modbus RTU Protocol.....	88
Table 6.2: Tubing Definition in Modbus RTU Protocol.....	88
Table 7: EMC items	90
Table 8: Parameter List of Programming Modules	91
Table 8 (1): Parameter list of Constant Speed Module	91
Table 8 (2): Parameter List of Ramp Up Module	92

Table 8 (3): Parameter list of Ramp Down Module	92
Table 8 (4): Parameter list of stepped up module	92
Table 8 (5): Parameter list of stepped down module.....	93
Table 8 (6): Parameter list of constant dispensing module	93
Table 8 (7): Parameter list of incremental dispensing module	94
Table 8 (8): Parameter list of decremental dispensing module	94
Table 8 (9): Parameter List of Sine Module	95
Table 8 (10): Parameter List of Control Module	95
Table 9 Modbus RTU Protocol Data Structure Table for Steps	96
Table 9 (1) Constant Speed Module	96
Table 9 (2) Ramp Up Module	97
Table 9 (3) Ramp Down Module.....	98
Table 9 (4) Stepped Up Module	99
Table 9 (5) Stepped Down Module	100
Table 9 (6) Sine Curve Module.....	101
Table 9 (7) Constant Dispensing Module.....	102
Table 9 (8) Incremental Dispensing Module	103
Table 9 (9) Decremental Dispensing Module.....	104
Table 9 (10) Direction Module	105
Table 9 (11) Pause Module	105
Table 9 (12) Loop Module	105
Table 9 (13) Event Trigger Module	106
Table 9 (14) Delay Module	106
Table 9 (15) Jump Module.....	106
Table 9 (16) External Output Module.....	107
Table 9 (17) Stop Module	107

1 General Information

1.1 Precaution

- All interfaces do not support hot-swap, and shall be plugged and unplugged with power off, otherwise it may easily cause malfunction.
- The interfaces at the rear of the driver should be protected from moisture and water.
- Rupture of tubes may cause fluid to spray out, so please replace tubing in time or use appropriate protective measures to ensure the safety of operators.
- When removing or replacing a tubing, make sure fluid in the tubing has been drained out, no pressure in the piping system and disconnect pump from mains power.
- Disconnect pump from the mains power before connecting the control wires.
- Do not touch the rotor while pump is running.
- Release the compression block when pump stop running for a long time to avoid tubing deformation caused by squeezing.
- Keep the rotor clean and dry, otherwise it will accelerate the wear of the tube and shorten the service life of the pump head and driver.
- Do not lubricate the roller of the pump head by yourself, any improper operation could corrode the pump head housing or dislocate the tubing.
- Connect the power cord, external control signal cable or communication control cable properly, and do not damage the plug.
- Pump head is not resistant to organic solvents and highly corrosive liquids, please clean the liquid left on the surface in time.
- Appearance or software is subject to upgrading, change, or discontinuation without notice.

1.2 Warranty and Service

1.2.1 Warranty commitment

(1) Longer, obligation under this warranty is limited to a period of one (1) year from the date of original purchase. Within the 1 year of warranty period, Longer will replace or repair any defective parts free of charge. This warranty doesn't cover consumable part (tubing).

(2) The failure or damage of the product under the following conditions, regardless of whether it is within the free warranty period, is not covered by the free warranty.

- The overall product has exceeded the warranty period;
- Failure or damage caused by improper installation, improper storage, improper maintenance, or improper use by product users failing to follow the instructions;
- Beyond the conditions agreed in the contract or technical agreement;
- Failure or damage caused by installation, repair, change or disassembly not by Longer service agencies or personnel;
- Failure or damage caused by the use of non-Longer parts or components or the replacement of spare parts by the user, in which the spare parts are not purchased from Longer or a designated dealer;
- Failure or damage due to unexpected factors or human reasons (including improper power supply voltage, corrosion, falling-off, etc.);
- Failure or damage caused by force majeure such as natural disasters (e.g., earthquakes, fires, etc.);
- Failure or damage not caused by the design, manufacturing or quality of the product;

1.2.2 Commitment for maintenance

- (1) If the product fails outside the warranty period, repairs and replacement of parts or accessories are charged at cost;
- Replacement of parts or components can be completed within 3 working days, and if such replacement cannot be completed within the time limit for maintenance, the estimated completion date will be given in advance.

1.2.3 Dispute settlement

If a dispute arises due to product quality, service, etc., it shall be settled in accordance with the contract or agreement. If there is no contract or agreement, the two parties concerned shall settle it by negotiation, otherwise, it shall be settled in accordance with relevant national laws and regulations.

1.3 Notes for product repair

If you need to return the product for repair, please contact Longer or an authorized distributor in advance, provide the product serial number, and indicate the customer's contact information and product failure symptoms. If the product has been exposed to toxic chemicals or other substances harmful to human health, please clean the product before returning it. The product must be properly packed in the original packaging or better to prevent damage to the pump during transportation.

1.4 Contact information

Baoding Longer Precision Pump Co., Ltd. (Headquarters)

Address: 3rd/4th Floor, Building 6B, University Science Park, Baoding National High-Tech Industrial Development Zone

Tel: 86-312-3110087

Fax: 86-312-3168553

Website: www.longerpump.cn

E-mail: longer@longerpump.com

2 Product Introduction

2.1 Main Features

The intelligent peristaltic pump series is a peristaltic pump driver with programming function, in which L100-1F and L100-1FS provide a maximum flow of 500mL/min, L300-1F and L300-1FS provide a maximum flow of 1500mL/min, and L600-1F and L600-1FS provides a maximum flow of 3000mL/min. The three products in the Lx00-1FS series also have the function of automatic identification of pump head and tubing. This series of products has a streamlined body design and a simple and elegant appearance. With the handle type design and comfortable grip, it facilitates the movement and placement of the pump. The 7 inch color display, full touch screen and intuitive graphic interface, provide easy-to-use operations. The parameters can be customized by programming, and the parameter programs can be stored and easily recalled. Multiple function modules and intelligent algorithms are designed for a wide variety of applications, including routine and multi-step complex applications. Pump can be controlled through touch screen, foot switch, analog signal and communication commands, combined with a variety of interfaces (USB, RJ11, DB9, etc.) to facilitate system integration.

2.2 Unpacking

To unpack the pump, follow below steps:

- 1) Take out the equipment and accessories from the shipping carton.
- 2) Check the packing list to make sure that the accessories are complete.
- 3) In case of any question, please contact Longer or your local distributor.

2.3 Product System Structure

The peristaltic pump contains the following parts

- ① L100-1F / L100-1FS / L300-1F / L300-1FS / L600-1F / L600-1FS peristaltic pump drive
- ② Pump head + tubing

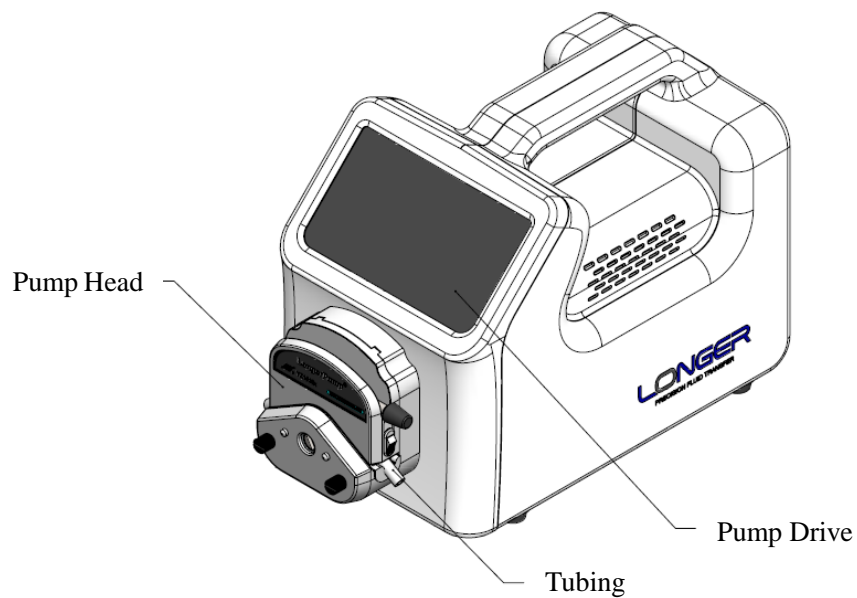

Figure 2-1 System structure of peristaltic pump

2.3.1 Pump Drive

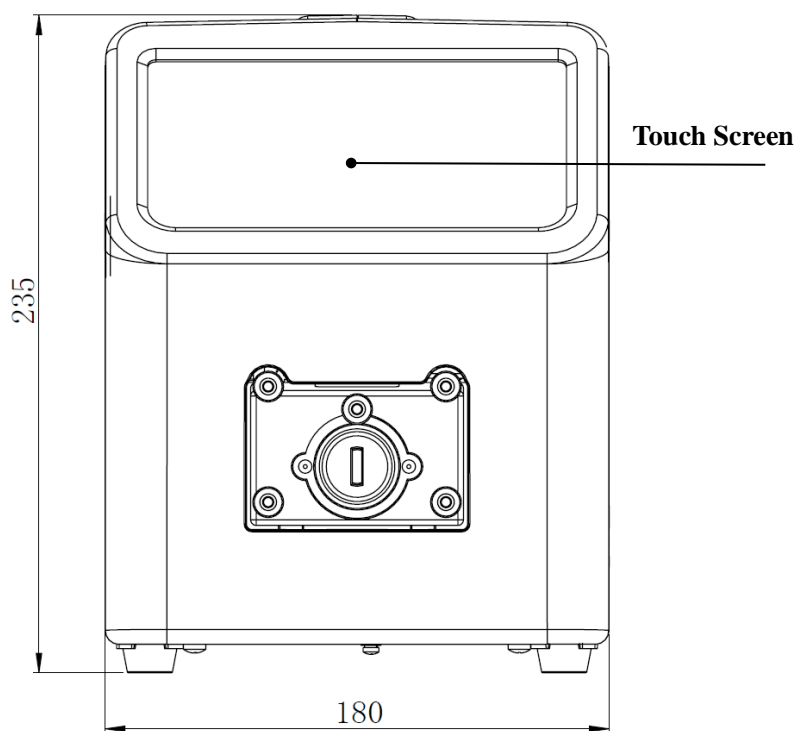

Figure 2-2 Front view of the pump drive

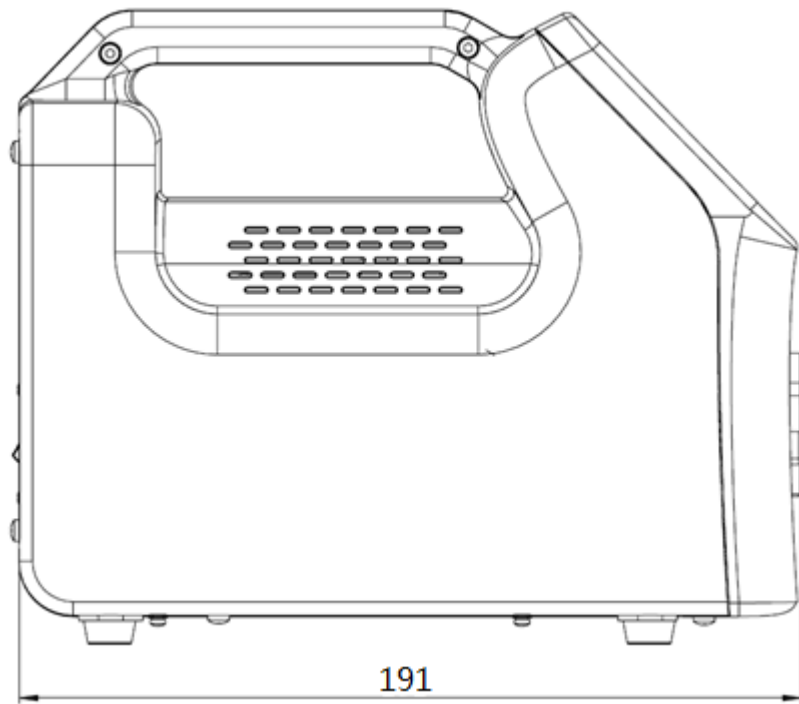

Figure 2-3 Side view of the pump drive

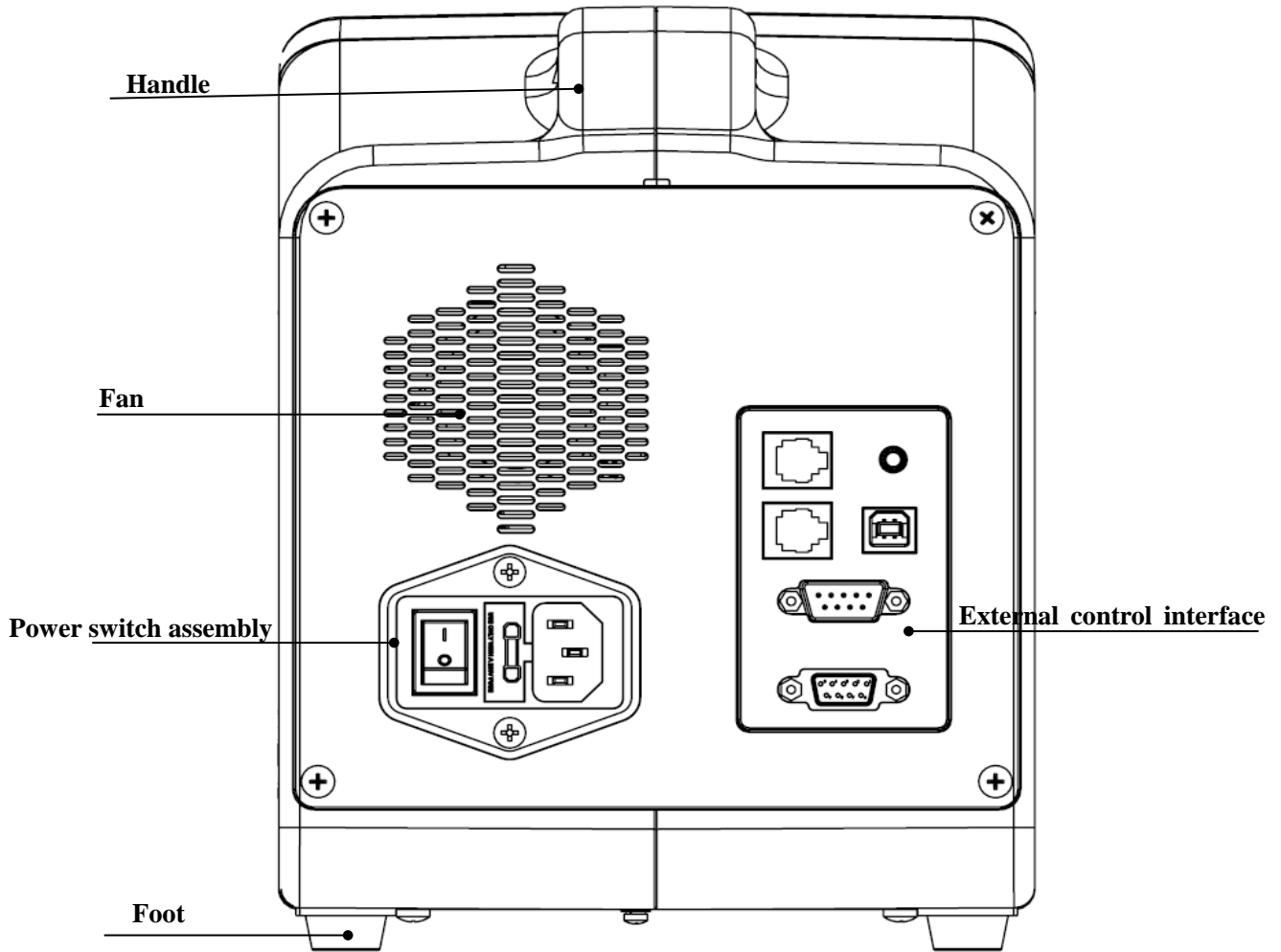
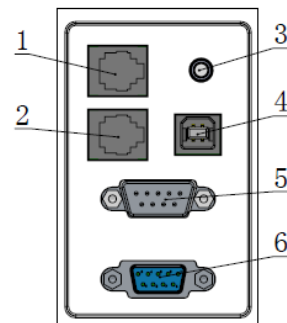
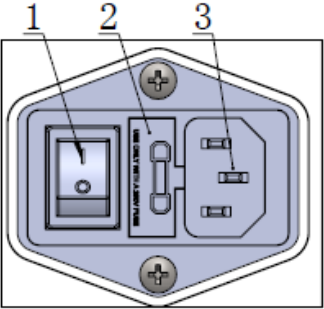

Figure 2-4 Rear view of the pump drive

Description of external control interface panel	
No.	Designation
1	RS485 input interface, in the form of RJ11
2	RS485 output interface, in the form of RJ11
3	Foot switch interface, in the form of 3.5mm headset jack
4	USB communication interface, USB-B socket
5	External control input interface, in the form of DB9 (male)
6	External control output interface, in the form of DB9 (female)



Description of power switch assembly		
No.	Designation	
1	Power switch	
2	Power fuse socket	
3	Power socket	

2.3.2 Applicable Pump Head and Tubing, and Reference Flow Rate

Table 1: The pump head and tubing are used to transfer the fluid. Please refer to below table for the applicable pump heads and tubings

Applicable pump head	Applicable silicone tubing	Applicable Pharmed tubing	Reference flow rate with silicone tubing (single channel)		
			L100-1F/ L100-1FS	L300-1F/ L300-1FS	L600-1F/ L600-1FS
YZ1515x YZ II 15	13#, 14#, 19#, 16#, 25#, 17#, 18#	13#, 14#, 19#, 16#, 25#, 17#, 18#	6.3uL/min- 366mL/min	6.3uL/min- 1100 mL/min	6.3uL/min- 2200 mL/min
FG15-13	13#, 14#, 19#, 16#, 25#, 17#, 18#	13#, 14#, 19#, 16#	6.3uL/min- 358mL/min	6.3uL/min- 1075 mL/min	6.3uL/min- 2150mL/min
DMD15-13- B	2*13#, 2*14#, 2*19#, 2*16#, 2*25#	2*13#, 2*14#, 2*19#, 2*16#	13uL/min- 345 mL/min	13uL/min- 1035 mL/min	13uL/min-2070 mL/min
DG15-24	16#, 25#, 17#	Not recommended	81uL/min- 300 mL/min	81uL/min- 900 mL/min	81uL/min-1800 mL/min
BZ15-13-A	14#	14#	25uL/min- 25 mL/min	25uL/min-75 mL/min	25uL/min-150 mL/min
BZ15-13-B	16#	16#	76uL/min- 76 mL/min	76uL/min- 230 mL/min	76uL/min-460 mL/min
BZ15-13-C	25#	25#	160uL/min- 160 mL/min	160uL/min- 480 mL/min	160uL/min-960 mL/min

BZ15-13-D	17#	Not recommended	266uL/min-266 mL/min	266uL/min-800 mL/min	266uL/min-1600 mL/min
YZ2515x	15#, 24#	Not recommended	160uL/min-266 mL/min	160uL/min-800 mL/min	160uL/min-1600 mL/min
YZ II 25	15#, 24#, 35#, 36#	Not recommended	160uL/min-500 mL/min	160uL/min-1500 mL/min	160uL/min-3000 mL/min
FG25-13	15#, 24#	Not recommended	228uL/min-321 mL/min	228uL/min-965 mL/min	228uL/min-1930 mL/min
BZ25-13-B	24#	Not recommended	266uL/min-266 mL/min	266uL/min-800 mL/min	266uL/min-1600 mL/min
DG-1-A (C)	ID≤3.17mm Wall thickness: 0.8-1mm	ID≤3.17mm Wall thickness: 0.8-1mm	0.20uL/min-48mL/min (recommended pump speed ≤100rpm)		
DG-2-A (C)	ID≤3.17mm Wall thickness: 0.8-1mm	ID≤3.17mm Wall thickness: 0.8-1mm			
DG-4-A (C)	ID≤3.17mm Wall thickness:0.8-1mm	Not recommended			
DG-6-A (C)	ID≤3.17mm Wall thickness: 0.8-1mm	Not recommended			
DG-8-A (C)	ID≤3.17mm Wall thickness: 0.8-1mm	Not recommended			
DG-1-B (D)	ID≤3.17mm Wall thickness: 0.8-1mm	ID ≤3.17mm Wall thickness: 0.8-1mm	0.16uL/min-39mL/min (recommended pump speed ≤100rpm)		
DG-2-B (D)	ID ≤3.17mm Wall thickness: 0.8-1mm	ID≤3.17mm Wall thickness: 0.8-1mm			
DG-4-B (D)	ID≤3.17mm Wall thickness: 0.8-1mm	Not recommended			
DG15-28	ID≤3.17mm, wall thickness:	ID≤3.17mm Wall thickness:	0.21uL/min-77mL/min (recommended pump speed ≤100rpm)		

	0.8-1mm and 13#, 14#	0.8-1mm	
--	-------------------------	---------	--

Note: The flow rate in above table is only for the reference, which were tested at the indoor temperature (about 20°C) with water. When it comes to selecting pump heads and tubings based on flow rate, the effects of tube attenuation and liquid viscosity on flow need to be considered.

2.4 Function & Specification

Table 2: Function & Specification

Pump model	L100-1F-A L100-1F-B	L100-1FS-A L100-1FS-B	L300-1F-A L300-1F-B	L300-1FS-A L300-1FS-B	L600-1F	L600-1FS
Automatic identification of pump head and tubing	No	Yes	No	Yes	No	Yes
Speed	0.1rpm-100rpm CW/CCW		0.1rpm-300rpm CW/CCW		0.1rpm-600rpm CW/CCW	
Speed resolution	0.1rpm		When the pump speed is less than 100rpm, the resolution is 0.1rpm; when the pump speed is more than 100rpm, the resolution is 1rpm			
Flow rate	0.16ul/min-500ml/min		0.16ul/min-1500ml/min		0.16ul/min-3000ml/min	
Power supply	L100-1F-A/L300-1F-A: AC220V±20%, 50Hz/60Hz L100-1F-B/L300-1F-B: AC110V±20%, 50Hz/60Hz				AC100V-240V, 50Hz/60Hz	
Dispensing volume	100uL-9999L (Accuracy of ±2% with calibration)					
Calibration function	Enter the measured pumping volume and automatically calibrate the flow rate and dispensing volume					
Display	7-inch high-definition color LCD with display resolution of 1024× 600;					
Display language	Chinese or English, which is settable					
Control mode	Touch screen control, foot switch control, external signal control, communication control					
Work mode	Programming					
Parameter method function	Seven parameter methods can be customized and saved, one external control method is preset, and each method parameter can be directly called.					
Programming function	Running control module (which can be used independently): Fluid transferring control: Constant speed, ramp up, ramp down, stepped up, stepped down, sine Dispensing control: constant dispensing, incremental dispensing, decremental					

	<p>dispensing</p> <p>Logic control module (steps can be triggered through external signals and pump status can be output to other equipment; refer to [Table 5] for details):</p> <p>Direction, delay, event trigger, external control output, pause, jump, loop, stop</p> <p>Multiple function modules can be configured in combination for multi-step and complex fluid transferring</p>
External signal control	<p>In Parameter Method 8, the start, stop, direction and pumpspeed are controlled by digital and analog signals; refer to [Table 3] for details.</p> <p>Start-stop control/direction control: logic level signal and switch signal are optional.</p> <p>Speed control: 0-5V/0-10V/4-20mA/0-10kHz is optional with uniform interface, and the maximum speed can be set.</p>
Communication function	Modbus protocol, multiple baud rates (1200/2400/4800/9600/19200 / 38400bps), USB and RS485 (RJ11) interface for connection, refer to [Table 6] for details.
Status output	<ol style="list-style-type: none"> 1. Output logic level signal to indicate the pump running status and direction status; refer to [Table 3] for details. 2. Output switch signal at the specified step of the programmed method through the "External Control Output" module; refer to [Table 5] for details.
Foot switch control	Through the dedicated headset-jack interface, in Parameter Method 6 or Parameter Method 7 (only for constant fluid transferring, and only has one constant speed step, or only for constant dispensing, and only has one constant dispensing step. The direction module can be used to set the running direction), the foot switch can be used to control the start/ stop of the pump; refer to [Table 4] for details
Parameter Memory	Memorize the working parameters set before power off;
Animation function	Animated graphics show the running and direction status information of the pump;
Prime function	Fast filling or emptying at full speed to achieve pre-treatment and post-treatment of liquids
Scheduled start function	The user can set the delay start time, and the pump will start running at desired time.
Fluid coefficient setting	The user can set the fluid coefficient, which is convenient for adjusting and calibrating the flow rate of viscous liquid;
Back suction function	Antidrip through setting back suction angle and the suction delay time
Dispensing volume setting range	0.001uL-9999L
Dispensing	0.5s-9000s

time and interval time setting range	
Dispensing cycle setting range	1-999999 (0 for unlimited)
Fluid transferring time setting range	1s-9000s (0s means continuous transferring without time limit)
Back suction delay time setting range	0.00s-60.00s
Program download function	The user can upgrade the firmware of the pump through a PC, which facilitates the updating of subsequent versions.
IP rating	IP31;
EMC	Key indicators reach or exceed level II; refer to [Table 7] for details.
Operating environment	Operating temperature: 0°C~40°C, relative humidity: <80%;
Outline dimensions	180mm × 291mm × 236mm (Length × width × height);
Total weight	5.0Kg;

Module Function

1	Constant speed	Transfer the fluid with constant flow rate. Parameters of flow rate, volume, time can be set. Refer to Table 8 for parameter details.
2	Ramp up	Transfer the fluid according to a linearly increasing curve. The starting flow rate, ending flow rate, running time, and other key parameters can be set. Refer to Table 8 for parameter details.
3	Ramp down	Transfer the fluid according to a linearly decreasing curve. The starting flow rate, ending flow rate, running time, and other key parameters can be set. Refer to Table 8 for parameter details.
4	Stepped up	Transfer the fluid according to evenly stepped increasing flow rate. The starting flow rate, step time, step increment, step numbers and other key parameters can be set. Refer to Table 8 for parameter details.
5	Stepped down	Transfer the fluid according to evenly stepped decreasing flow rate. The starting flow rate, step time, step decrement, step numbers and other key parameters can be set. Refer to Table 8 for parameter details.
6	Constant	Dispense the fluid with constant volume. Dispensing volume, time, cycles and

	dispensing	interval time can be set. The filling output parameter and dispensing volume could be used to calculate other parameters for customer convenience. Refer to Table 8 for parameter details.
7	Decremental dispensing	Dispense the fluid with decremental volume. Refer to Table 8 for parameter details.
8	Incremental dispensing	Dispense the fluid with incremental volume. Refer to Table 8 for parameter details.
9	Sine	Transfer the fluid according to Sine Curve. Refer to Table 8 for parameter details.
10	Direction	Set the fluid transferring direction as CW or CCW.
11	Pause	The pump can be temporarily stopped during operation by using pause module. The pause state will be terminated by receiving an external trigger signal, or manually pressing the "Continue" button that appears on the running screen, and continue to execute the next steps in the method.
12	Loop	Repeatedly execute some steps in sequence (from the start step to the end step).
13	Event Trigger	When pump receives trigger signal, the pump will immediately stop the current operation (including the loop), and instead, execute the jump step set in the event trigger module.
14	Delay	Pump can be temporarily stopped for a period of time during the running process by using delay module, which can be used at the beginning of a method for schedule start time or between modules for temporarily stop.
15	Jump	When the pump is running the jump module and receiving a jump signal, the pump will immediately stop the current operation and go to execute the set jump step in the jump module.
16	External control output	Pump will output 2 signals when pump is running the external control output module.
17	End	End module is always used at the last step in a method, to represent the termination of the method.

3 System Installation

Please assemble the product correctly before use.

3.1 Outline Dimensions

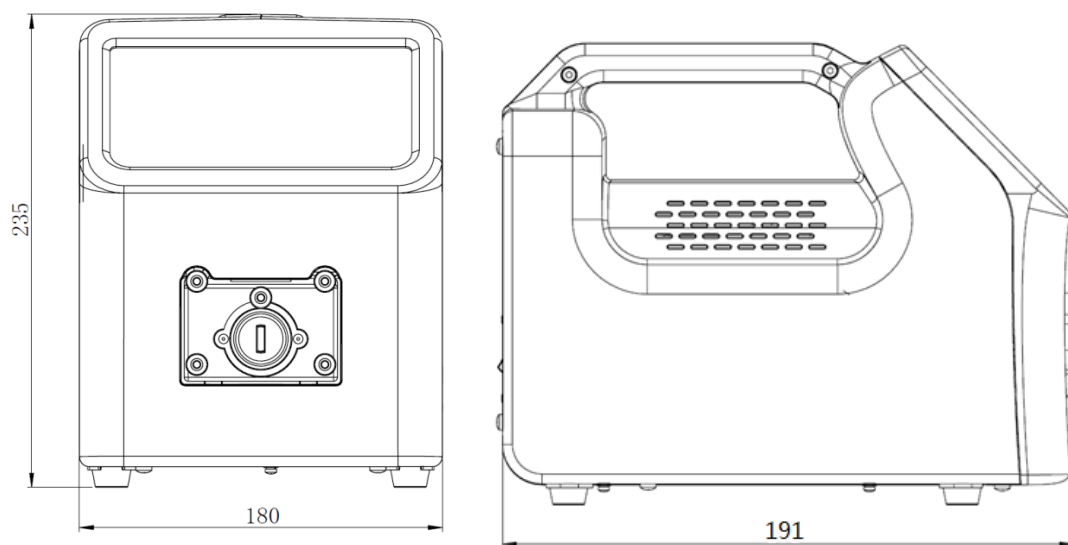

3.2 Installation of Pump Head

3.2.1 Installation of Pump Head YZ1515x/YZ2515x/YZII15/YZII25

Insert the tang of the pump head shaft into the slot of the black rubber coupling, push it in gently, and rotate the pump head to insert the alignment pin of the drive unit into the alignment hole on the back of the pump head, then tighten the mounting screws.

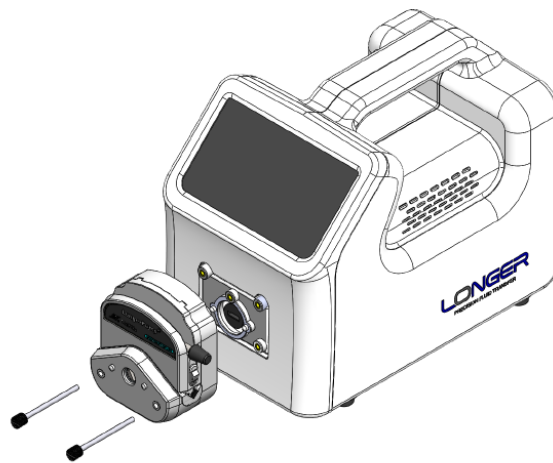

3.2.2 Installation of Pump Head FG15-13/FG25-13

Mounting the pump head:

Mount the mounting plate on the drive unit through tightening three mounting screws M4X10. Insert the tang of the pump head shaft into the slot of the black rubber coupling, turn the pump head 45 degree relative to the vertical direction, engage the bayonet on the mounting plate with the bayonet slot on the back of the pump head, turn the pump head clockwise until it locks into an upright position.

Remove the pump head:

Push the locking lever back and turn the pump head anti-clockwise about 45 degree. Then take off the pump head from the mounting plate.

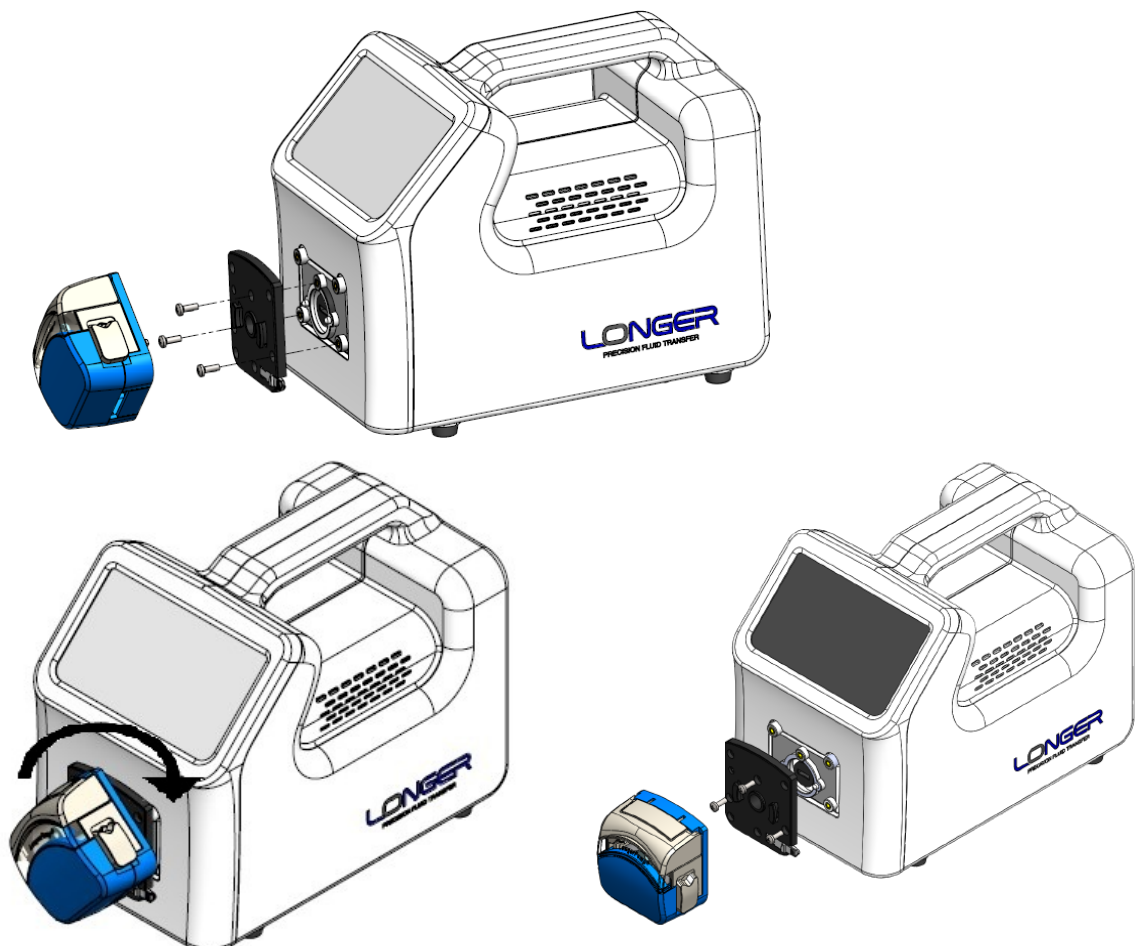

3.2.3 Installation of Pump Head DMD15-13 and Tubing

Pump Head Mounting:

Mount the mounting plate on the drive unit through three cross recess head screws M4X10. Release the two levers to open the pump head and remove the compression block. Insert the tang of the pump head shaft into the slot of the black rubber coupling. Press the pump head firmly against the mounting plate. Turn the pump head to align the mounting holes on the pump head with the mounting holes on the mounting plate. Insert the two mounting screws (hexagon socket head cap screw M3X8) into the mounting holes, then tighten them.

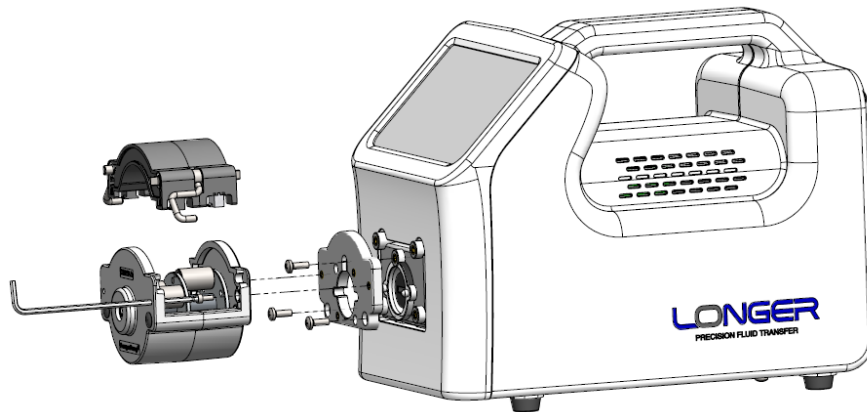

Tubing Loading:

Release the levers to remove the compression block. Insert the tubing fitting assembly into the compression block.

Note: When use 25# tubing, the partition block needs to be fixed at the outermost positioning hole.

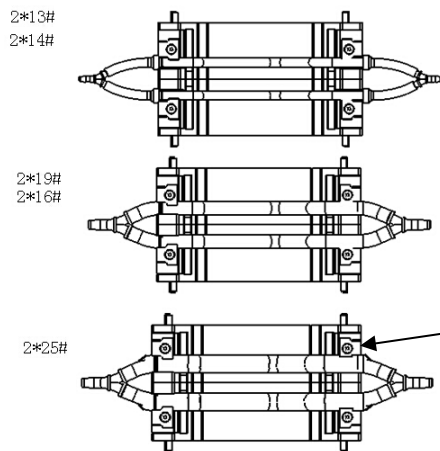

The four partition blocks need to be fixed at the outermost positioning holes

Put the compression block with tubing fitting assembly back to the pump head, and lock the levers according to the direction of the arrow.

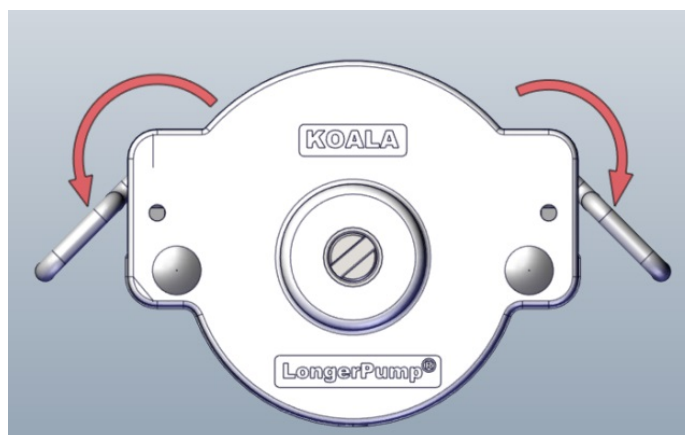

3.2.4 Installation of Pump Head BZ15-13/BZ25-13

Insert the tang of the pump head shaft into the slot of the black rubber coupling. Press the pump head firmly against the pump drive. Turn the pump head to align the mounting holes on the pump head with the mounting holes on the pump drive. Insert the 4 mounting screws into the mounting holes, then tighten them.

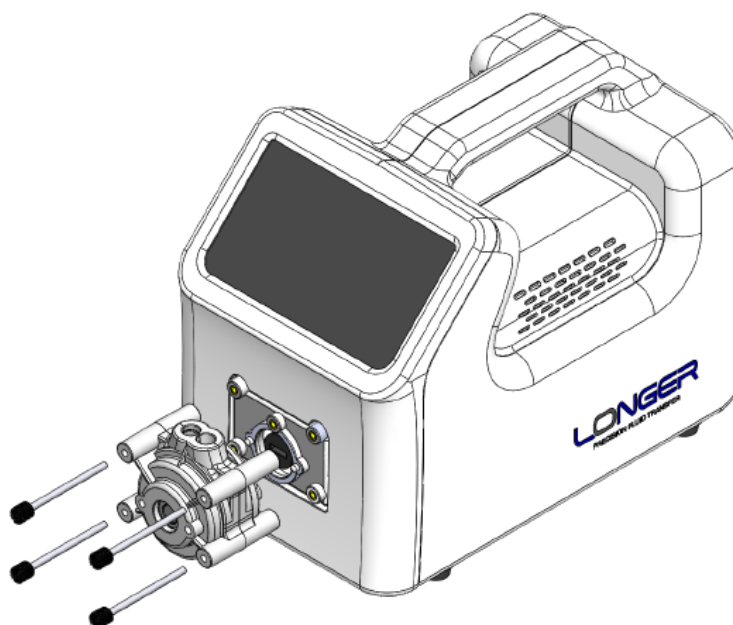

3.2.5 Installation of Pump Head DG15-24/DG15-28

Mount the mounting plate on the drive unit through four screws M4X10. Remove the tubing and the pump head cartridges. Insert the tang of the pump head shaft into the slot of the

black rubber coupling. Press the pump head firmly against the pump drive. Turn the pump head to align the mounting holes on the pump head with the mounting holes on the pump drive. Insert the 3 screws M4X16, then tighten them.

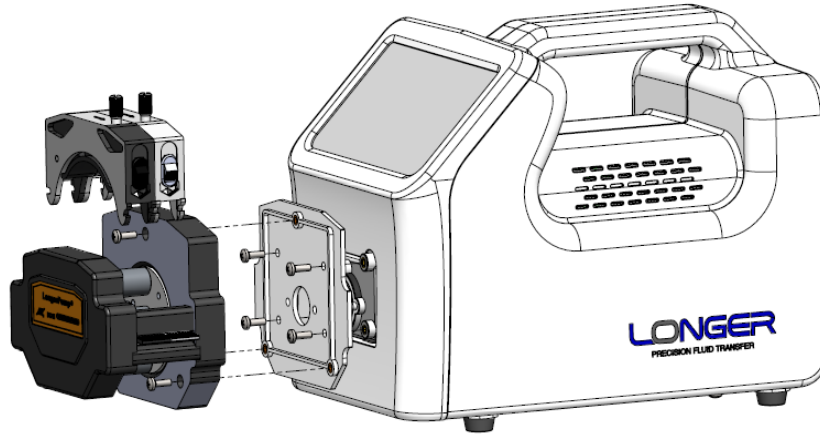

3.2.6 Installation of Pump Head DG Series

Remove the tubing and the pump head cartridges. Insert the tang of the pump head shaft into the slot of the black rubber coupling. Press the pump head firmly against the pump drive. Turn the pump head to align the mounting holes on the pump head with the mounting holes on the pump drive. Insert the 2 hexagon socket head cap screws M4X8, then tighten them.

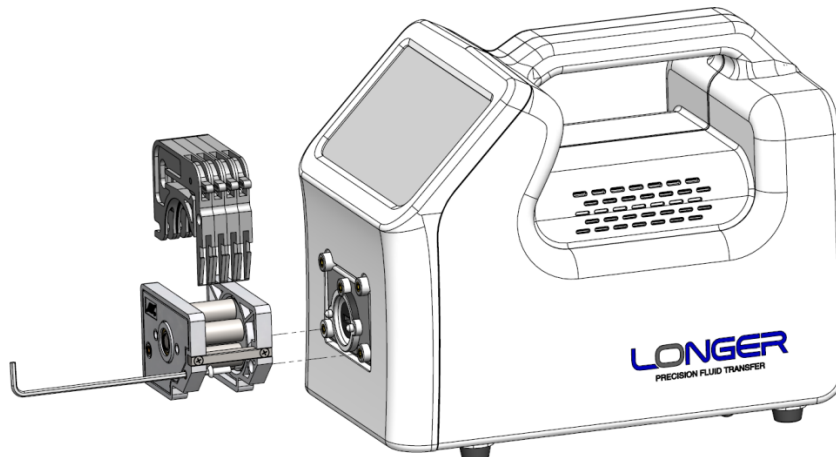

4 Operation

Start Screen

After power up, the screen will display the company logo of Longer, and then it will jump to the

standby screen.



4.1 Pretreatment



On the standby screen, by pressing the key “” to switch to the pretreatment screen, for quickly completion the filling preparation before work. Tap the icon to run the pump with desired direction, and tap again to stop.

CW: The pump runs at full speed clockwise.

CCW: The pump runs at full speed counterclockwise.

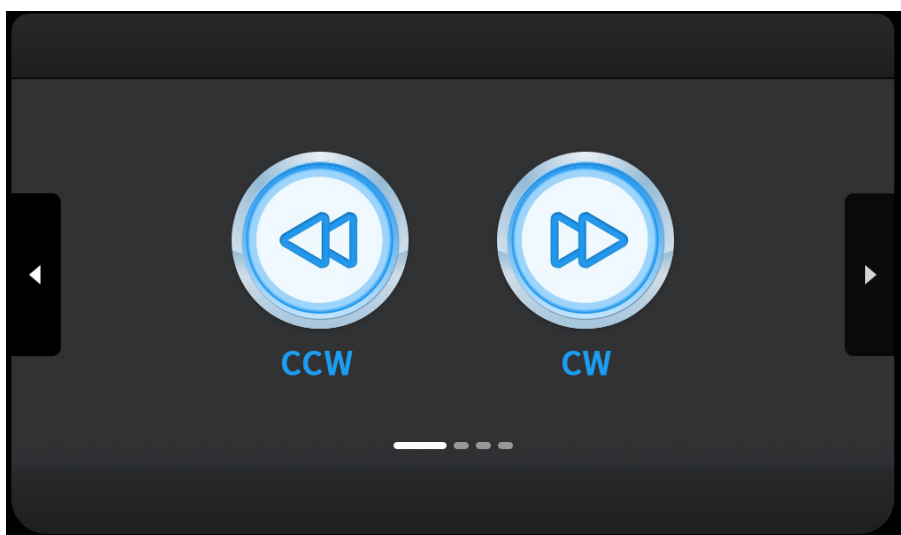
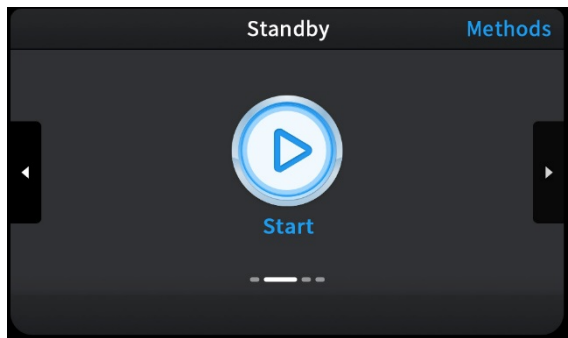
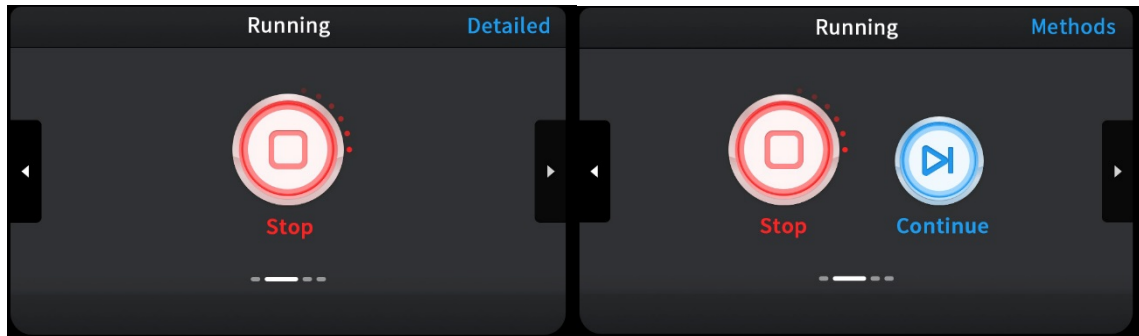

Figure 4-1

4.2 Standby Screen







Standby Screen

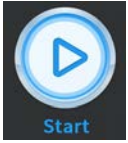

Running Screen

Pause Screen

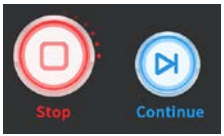
Figure 4-2

No.	Key icon	Function
1		The left and right arrows are keys for switching the operation screens.
2		Start key, tap it to start pump operation according to the selected method.
3		After startup, tap the stop key to stop the operation.
4		After the pump is started, when it reaches the "pause" logic module of the method, the pump will pause, and the Continue key will be effective. Tap the Continue key to continue the operation; tap Stop key to stop the operation.
5		In the stopped state, tap the "Methods" key in the upper right corner of the screen to enter the method selection screen.
6		In the running state, tap the "Detailed" key in the upper right corner of the screen to display the detailed information screen of the current method.

4.3 Method Programming

Method programming steps:

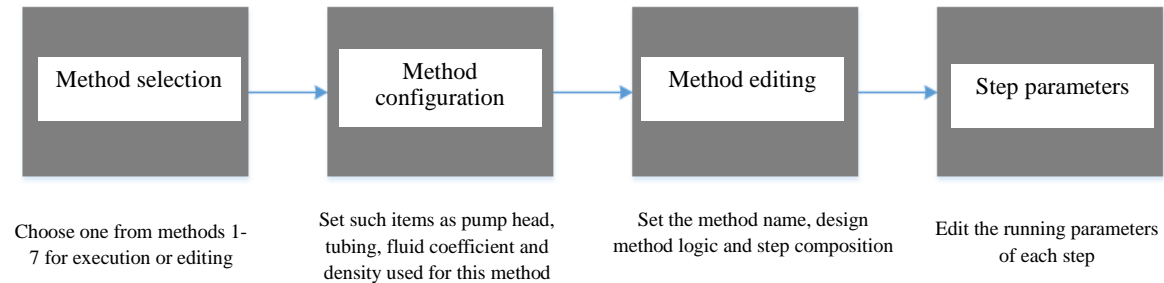

4.3.1 Method Selection

The operating parameters of the pump can be saved as a method and called directly when used. Operating parameters include: pump head model, tubing size, fluid density, fluid coefficient, method logic, and parameters of included modules.

When pump is stopped, tap the "Method" key on the standby screen to enter the method selection screen. 8 optional methods are displayed on the left side of the screen, showing the names of the methods, and a content preview of the selected method is displayed on the right side. Among the 8 optional methods, the first 7 methods can be used to program the logic and parameters of the pump's running process, and each method includes a maximum of 10 steps; The method 8 is an external control method. And when it is needed to use external signal to control the pump, the method 8 should be selected, and then set the pump head model, tubing size, fluid density, and fluid coefficient.

When it is needed to use the foot switch to control the start and stop of the pump, the Method 6 or Method 7 should be selected.

Tap the method name to select the method, and the selected method will be highlighted. If it is needed to set or change the method parameters, tap on the preview area on the right for method configuration and method editing. If it is not needed to change the method parameters, tap "<" to return to the standby screen. Then a dialog box for confirmation of the pump head & tubing will pop up. And if displayed information is consistent with the actual installation, press the "Confirm" key to return to the standby screen.



Figure 4-3

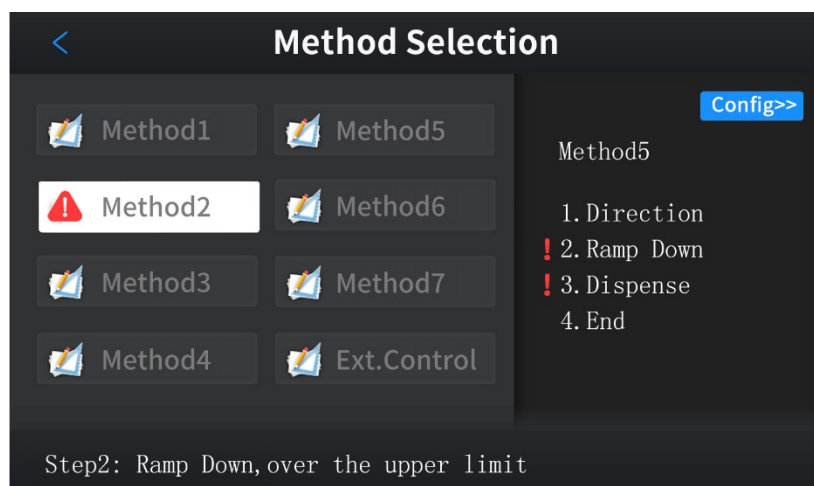
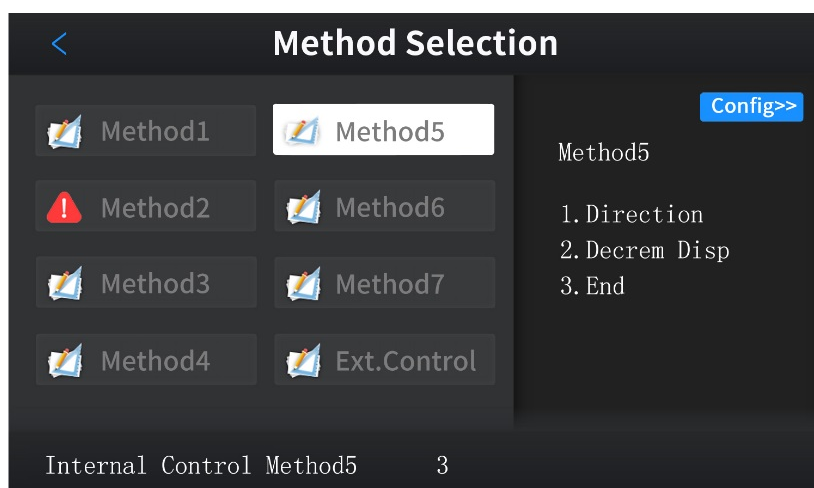

If there is the mark  in front of a method, it indicates that the method contains steps with parameter out-of-limit.

If there is the mark "!" in front of a step, it indicates that this step has parameter out of limit.

If there is a (Failure) mark behind the step, it means that this step will be skipped and not executed.

4.3.1.1 Confirmation of pump head and tubing

In the method selection screen (Figure 4-2), tap "<" to pop up the pump head & tubing confirmation screen, as shown in the figure below, to prompt the user to avoid setting errors.

If the displayed pump head and tubing are consistent with the actual installation, tap "OK" to return to the standby screen. If not, tap "Change" to enter the method configuration screen and reset them.

Note: This pump head and tubing confirmation function is only applicable to pumps with automatic identification of pump head and tubing (L100-1FS, L300-1FS, L600-1FS).

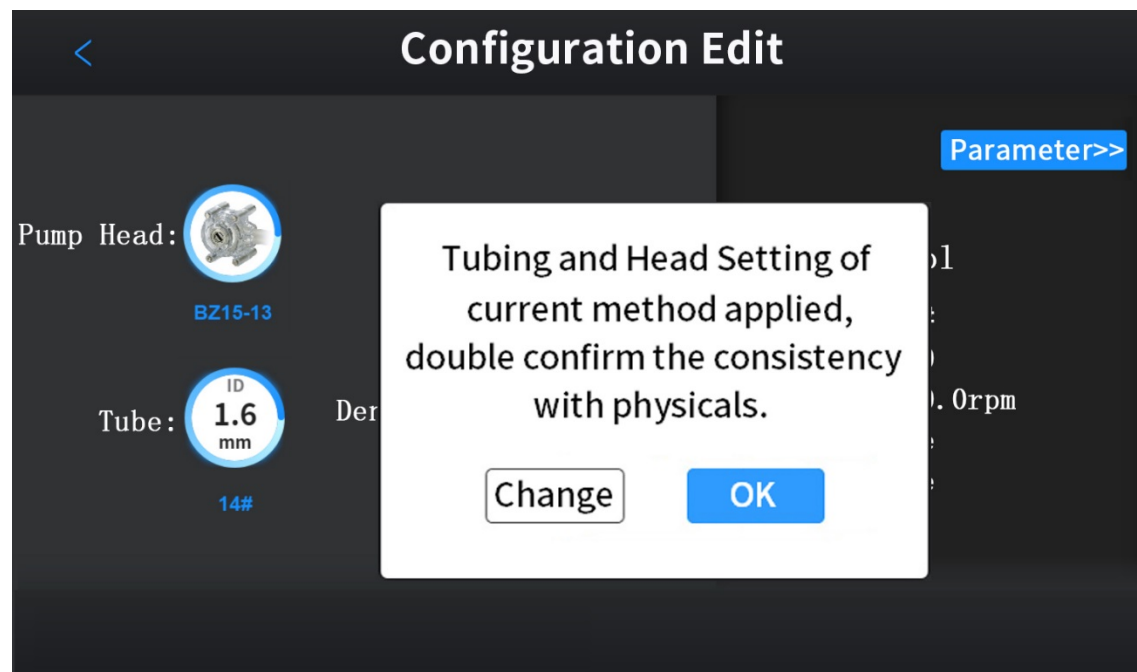

4.3.2 Method Configuration

Tap on the method preview area on the right of Figure 4-3 to enter the method configuration editing screen (Figure 4-4). The left is used to set the pump head, tubing, fluid coefficient and fluid density. On the right is a preview of the selected method step. (There is no method step in the external control mode, and external control information is displayed)

Tap the "Pump Head" icon to enter the pump head setting screen (Figure 4-5), and tap the "Tubing" icon to enter the tube setting screen (Figure 4-6). Tap the data field corresponding to fluid coefficient and fluid density to directly enter and edit the value of this setting item.

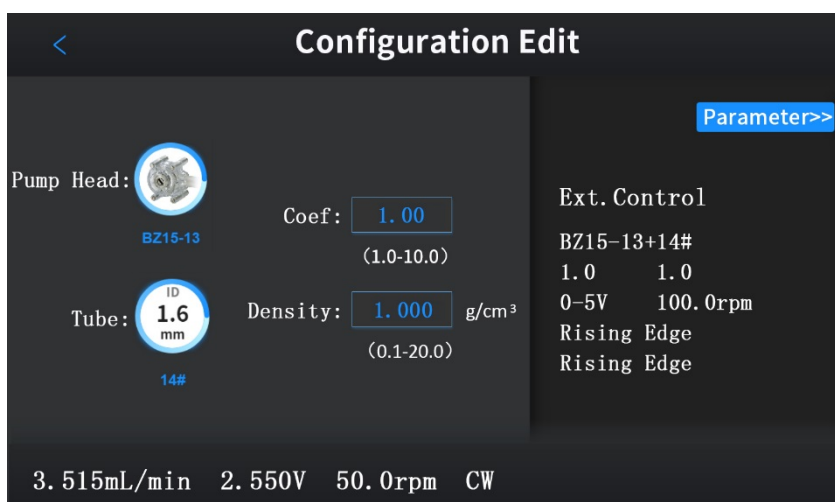

Figure 4-4

4.3.2.1 Selection Screens for Pump Head and Tubing

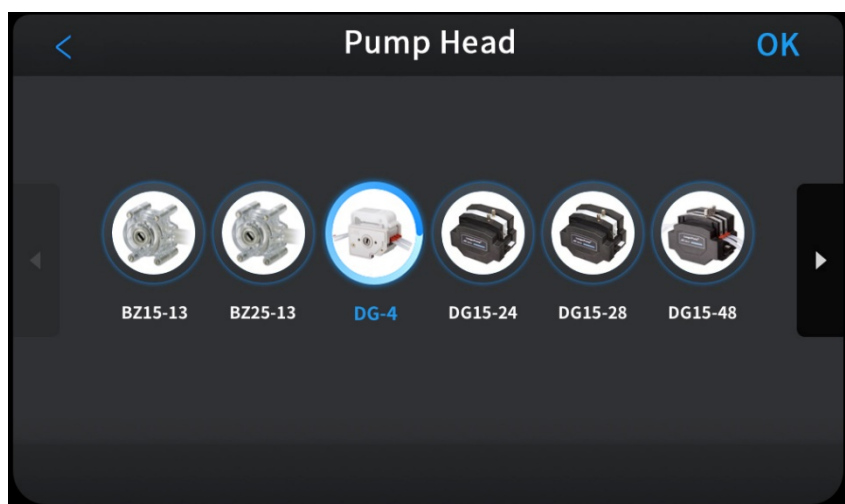

Figure 4-5

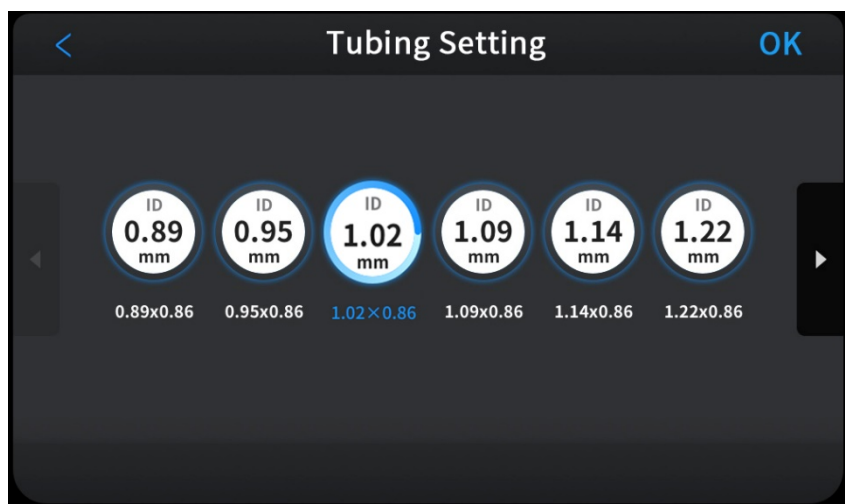

Figure 4-6

In the pump head selection screen, select the suitable pump head according to the product model, and the selected pump head will become highlighted; tap the "OK" key in the upper right corner of the screen to enter the corresponding tubing selection screen; press the "<" key to return to the configuration screen.

In the tubing selection screen, select the applicable tubing according to the tubing size and the flow rate prompt, and the selected tubing will become highlighted; tap the "OK" key in the upper right corner of the screen to complete the setting, and the selected item will automatically switch to the first position. Press "<" to return to the configuration screen.

4.3.2.2 Setting Screen of Fluid Coefficient and Fluid Density

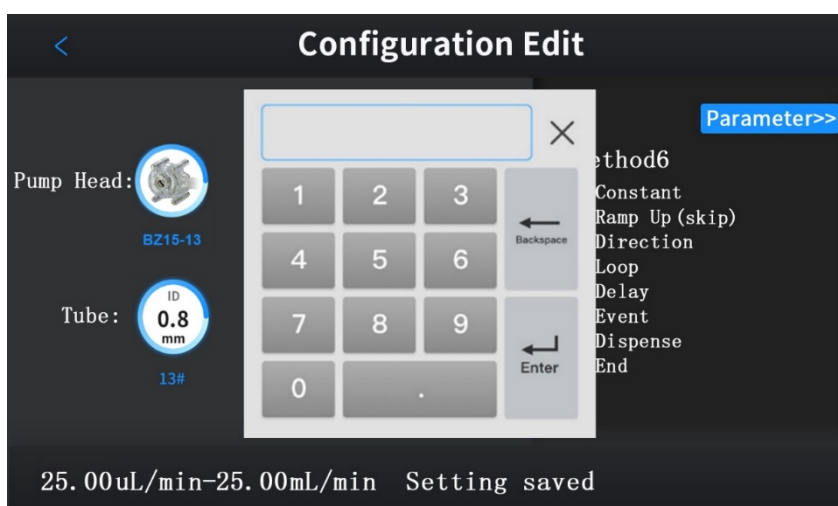

Figure 4-7

Fluid coefficient: The fluid coefficient of water is defined as 1. The value range of fluid coefficient is 1.0-10.0. Example: With YZ1515x pump head, 16# tubing. When the liquid to be transferred is water, the flow rate is 10 ml/min (Fw), and when the liquid of another viscosity is transferred,

the flow rate is 5 ml/min (Fo); then the fluid coefficient (K1) = $F_w / F_o = 2$.

Fluid density: The density of the transferred liquid, in g/cm³, and the value range is 0.1 to 20.0. The default is the density of water: 1g/cm³.

After the pump head, tubing, fluid density and fluid coefficient are set completely, if it is needed to perform method programming, tap the method parameter area on the right side of the screen to enter the method editing screen, as shown in Figure 4-8. If no method programming is required, tap the "<" key to return to the method selection screen.

4.3.3 Method Editing

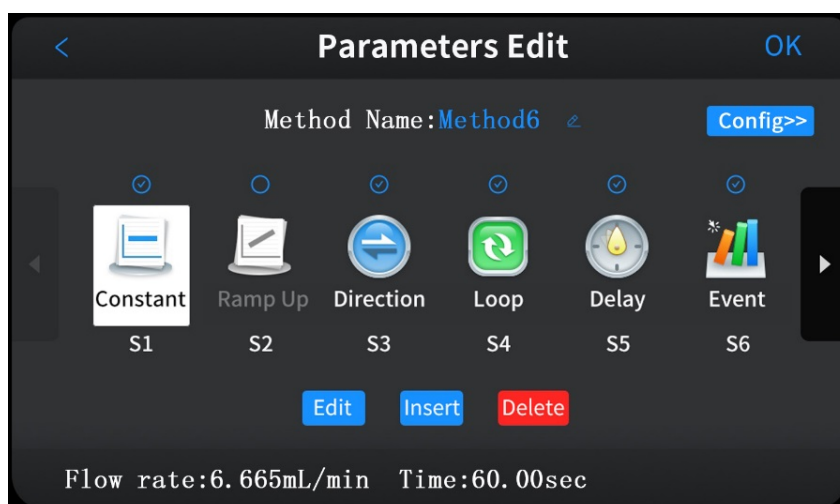

Figure 4-8

On the method parameter editing screen, tap the "Config>>" key at the top right of the screen, you can return to the method configuration screen for the configuration of such parameters as pump head and tubing;

In the method parameter editing screen, the method name can be changed, the working process of the pump can be constructed through modular programming, and the steps of the working process can be enabled or disabled.

4.3.3.1 Modification of Method Name

Tap on the method name to show a full English keyboard, on which the method name can be modified.

Note: On the keyboard, the uppercase and lowercase of English letters, numbers and special symbols can be switched by the "Shift" key. When the "Shift" key is blue, you can enter capital letters and the symbol at the upper position of double-symbol keys.

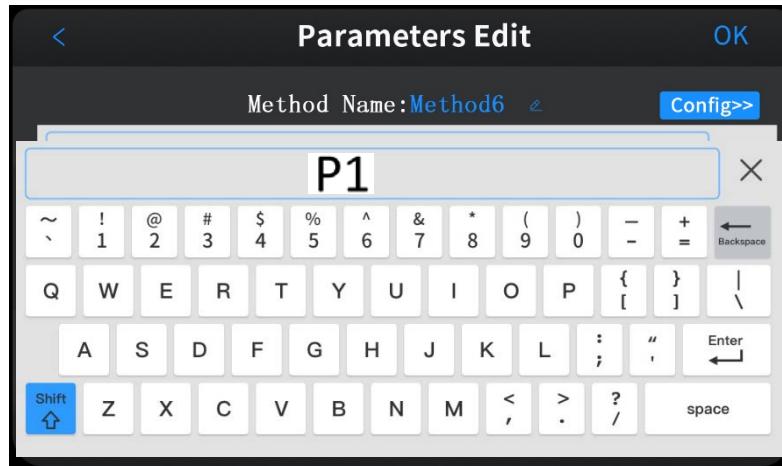

Figure 4-9

4.3.3.2 Modular Programming

The intelligent peristaltic pump provides a variety of functional modules, including 9 running control modules and 8 logic control modules. Modular programming is a workflow-based programming process, in which functional modules are arranged in sequence according to the running order to complete the target running process of the pump. The programming process includes only three simple operations: "Edit", "Insert" and "Delete".

"Edit": Edit the selected step, set the functional module and module parameters corresponding to the selected step.

"Insert": Insert a new step before the selected step, and set the functional module and module parameters corresponding to the inserted step.

"Delete": Delete current selected step.

When it comes to tapping "Edit" and "Insert", it will enter the module selection screen. Tap "Left Arrow" and "Right Arrow" in this screen to switch between the running control module selection screen and logic control module selection screen. The selected module icon is highlighted. Tap the highlighted icon again to enter the module parameter editing screen. After setting the parameters, tap "OK" to save the parameters and return to the method parameter editing screen. Press "OK" again in the method parameter editing screen to save the programming method.

Note: Please refer to Chapter 4.3.4 [4.3.4 Module parameter setting] for setting operation of module parameters.

When the pump is running, the functional modules of each step are sequentially executed from Step 1 (S1). When reaching the "End" module, the pump stops running.

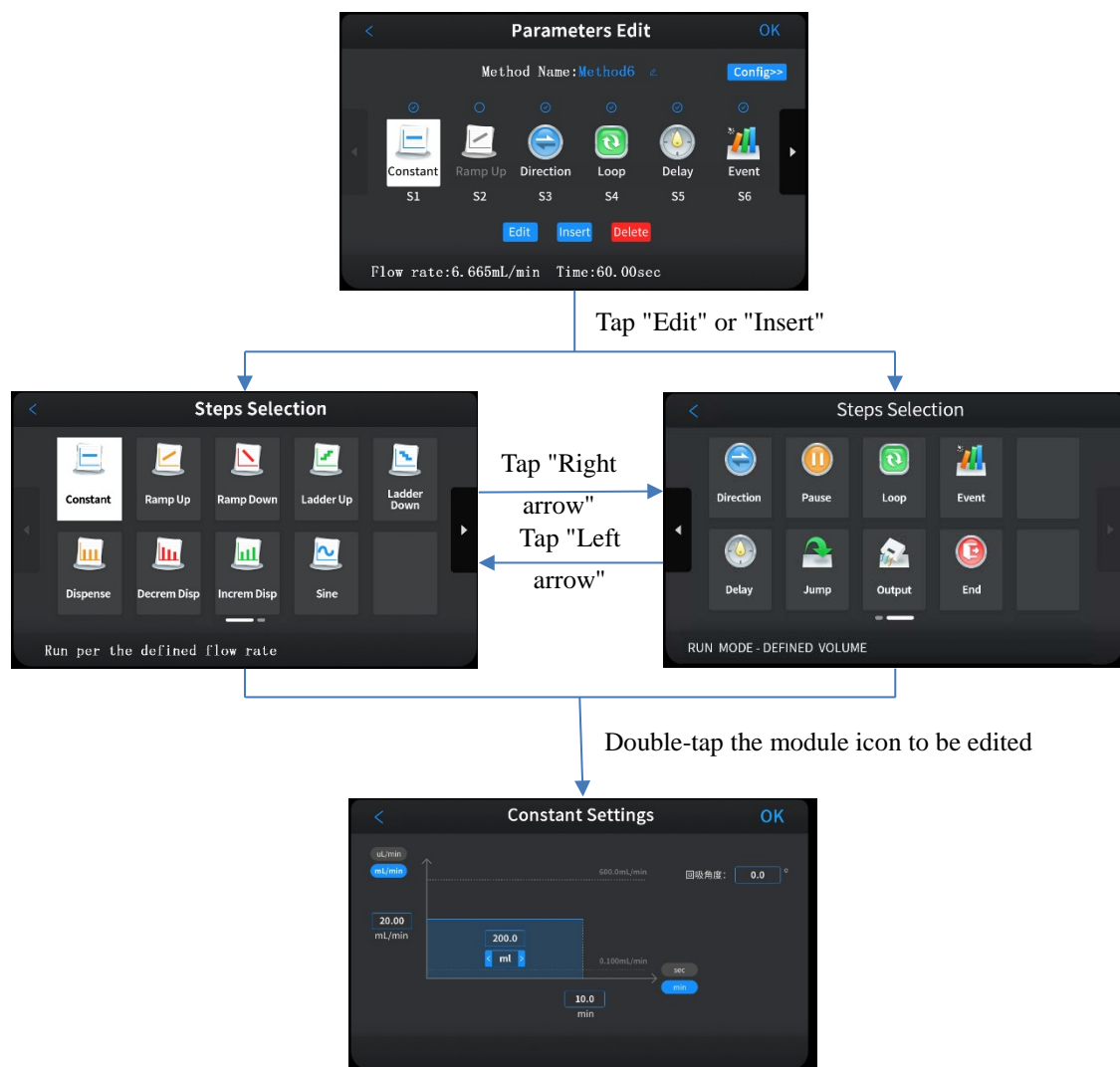

Figure 4-10

4.3.3.3 Enabling and Disabling of Method Steps

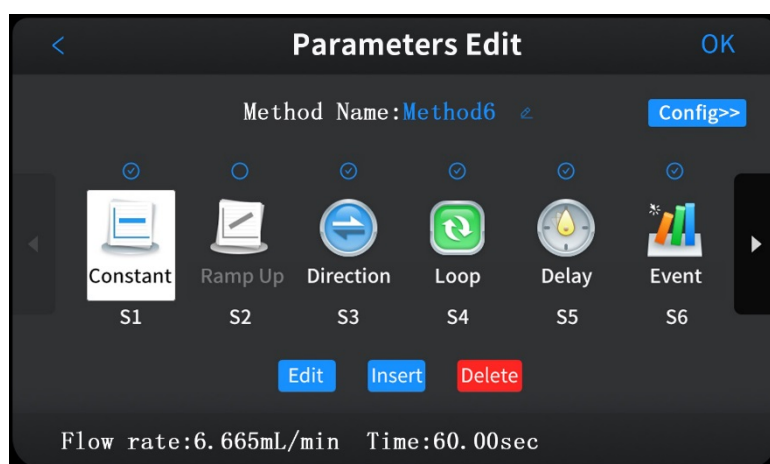



Figure 4-11

Enable or disable the step by tapping the circular icon above the step.

The icon is displayed as : This step is enabled, and when the pump is running, the module function corresponding to this step is executed.

The icon is displayed as : This step is disabled, and when the pump is running, this step is skipped and not executed.

4.3.4 Module Parameter Setting

The intelligent peristaltic pump provides 9 running control modules and 8 logic control modules.

Running control modules include: constant speed, ramp up, ramp down, stepped up, stepped down, sine, constant dispensing, decremental dispensing, incremental dispensing

Logic control modules include: direction, pause, loop, event trigger, delay, jump, external control output, end.

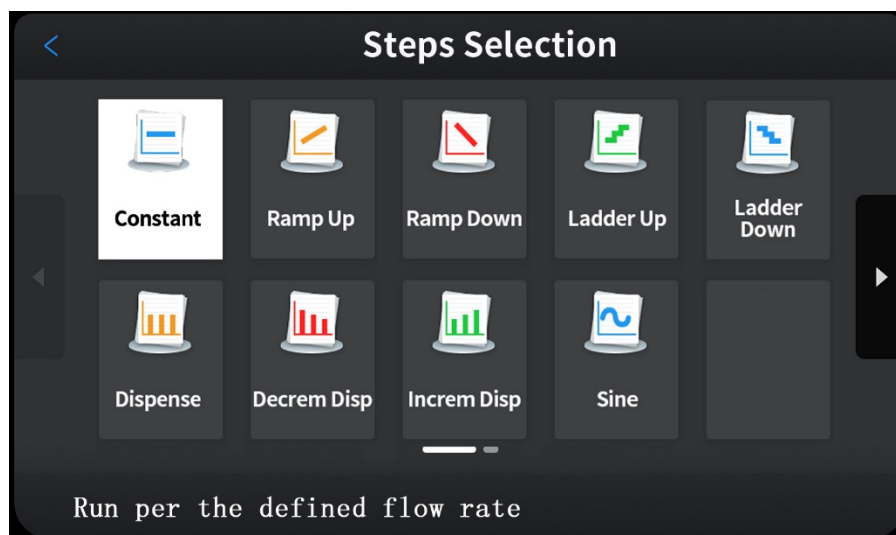

Figure 4-12

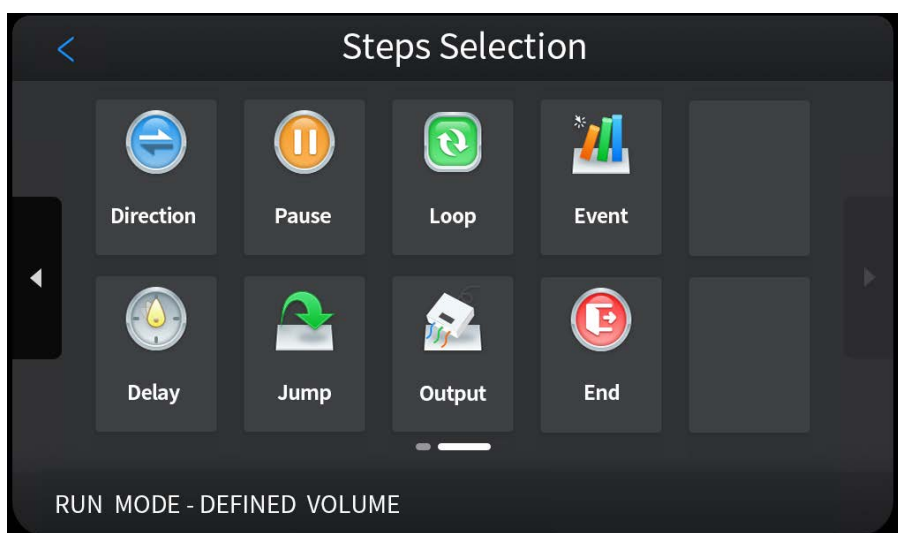

Figure 4-13

4.3.4.1 Parameter Setting of Constant Speed Module

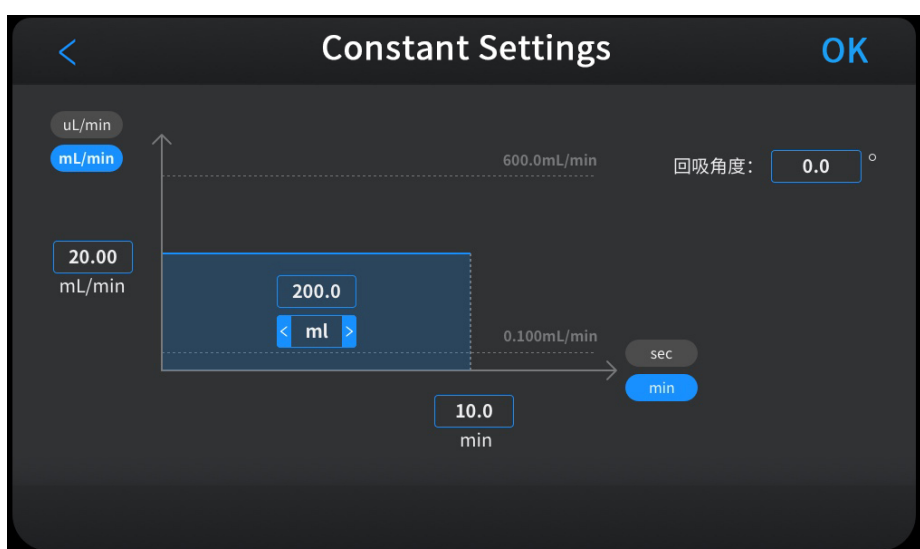

Figure 4-14

Function of constant speed module: within a set time, the pump runs at a constant speed with a fixed flow rate. After the running time is reached, the operation of this module is finished, and the pump continues to run the next functional module.

Flow rate: Tap the data field to enter it, the range is 0.001-9999, with unit: uL/min, mL/min, tap the ordinate axis unit to set the flow rate unit.

Liquid volume: Tap the data field to enter it, the range is 0.001-9999, with unit: uL, mL, L, tap the liquid volume unit to set the unit.

Running time: Tap the data field to enter it, 1sec-9000sec or 0.1min-150min, tap the horizontal axis unit to set the unit.

Note: It is only needed to select any two of the three parameters of flow rate, liquid volume and running time for input, and the third parameter will be calculated automatically.

Back suction angle: 0-999 degrees.

Flowrange indicator value: The maximum and minimum flow rate that can be supported according to the specifications of the currently set pump head and tubing. A prompt will be given when the value entered is out of limit.

Tap the "<" key at the top left of the screen to return to the module selection screen. Tap the "OK" key at the top right of the screen to save the current module parameters and return to the method parameter editing screen.

4.3.4.2 Parameter Setting of Ramp Up Module

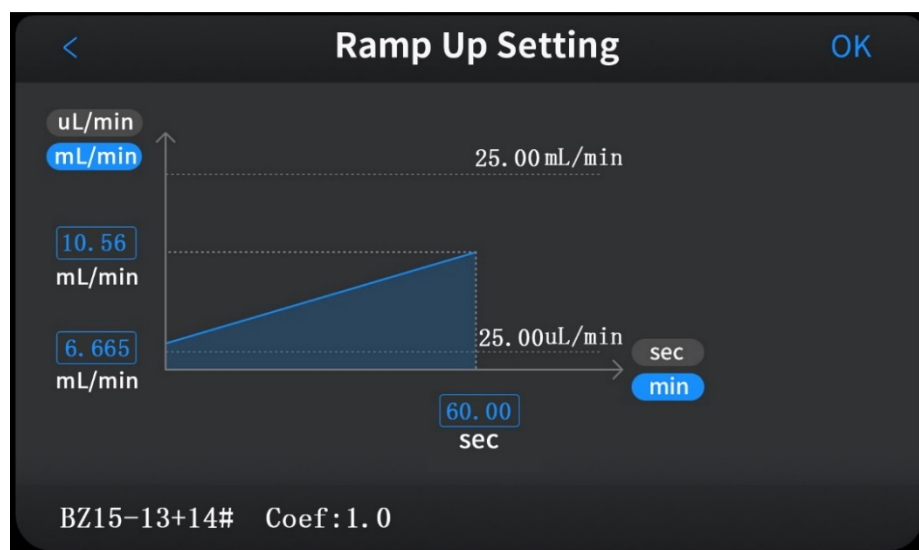

Figure 4-15

Function of ramp up module: Within a set time, the pump flow rate is increased linearly from the starting flow rate to the ending flow rate, and then the pump continues to run the next function module.

Starting flow rate: Tap the data field to enter it, the range is 0.001-9999, the unit is uL/min or mL/min, and tap the vertical axis unit to set the unit.

Ending flow rate: Tap the data field to enter it, the range is 0.001-9999, the unit is uL/min or mL/min, the same as the starting flow rate unit.

Running time: Tap the data field to enter it, 1sec-9000sec or 0.1min-150min. Tap the horizontal

axis unit to set the unit.

Flowrange indicator value: The maximum and minimum flow rate that can be supported according to the specifications of the currently set pump head and tubing. A prompt will be given when the value entered is out of limit.

Note:

Minimum flowrate<= Starting flow rate<Ending flow rate<= Maximum flow rate

Tap the "<" key at the top left of the screen to return to the module selection screen. Tap the "OK" key at the top right of the screen to save the current module parameters and return to the method parameter editing screen.

4.3.4.3 Parameter Setting of Ramp Down Module

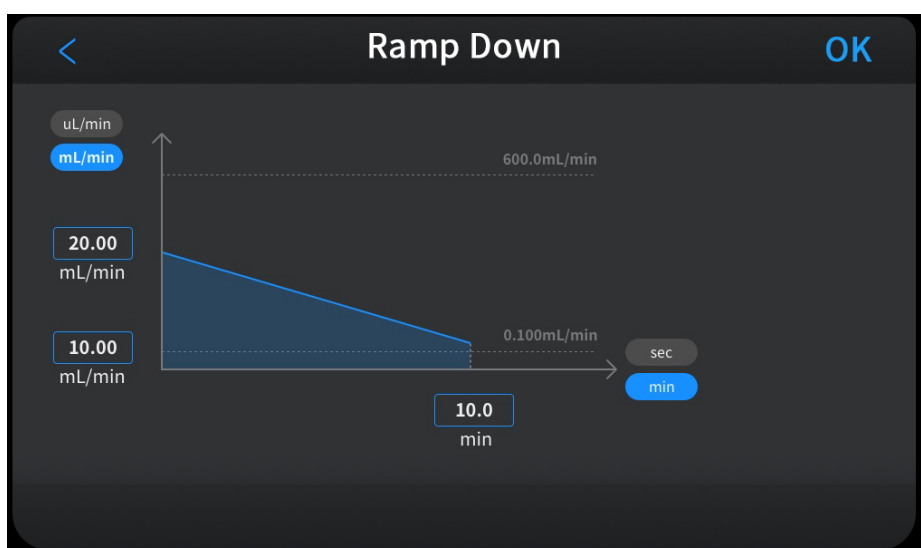

Figure 4-16

Function of ramp up module: Within a set time, the pump flow is decreased linearly from the starting flow rate to the ending flow rate, and then the pump continues to run the next function module.

Starting flow rate: Tap the data field to enter it, the range is 0.001-9999, the unit is: uL/min or mL/min, and tap the vertical axis unit to set the unit.

Ending flow rate: Tap the data field to enter it, the range is 0.001-9999, the unit is: uL/min or mL/min, the same as the starting flow rate unit.

Running time: Tap the data field to enter it, 1sec-9000sec or 0.1min -150min. Tap the horizontal axis unit to set the unit.

Flowrange indicator value: The maximum and minimum flow rate that can be supported according to the specifications of the currently set pump head and tubing. A prompt will be given when the value entered is out of limit.

Note:

Maximum flow rate \geq Starting flow rate $>$ Ending flow rate \geq Minimum flow rate

Tap the "<" key at the top left of the screen to return to the module selection screen. Tap the "OK" key at the top right of the screen to save the current module parameters and return to the method parameter editing screen.

4.3.4.4 Parameter Setting of Stepped Up Module

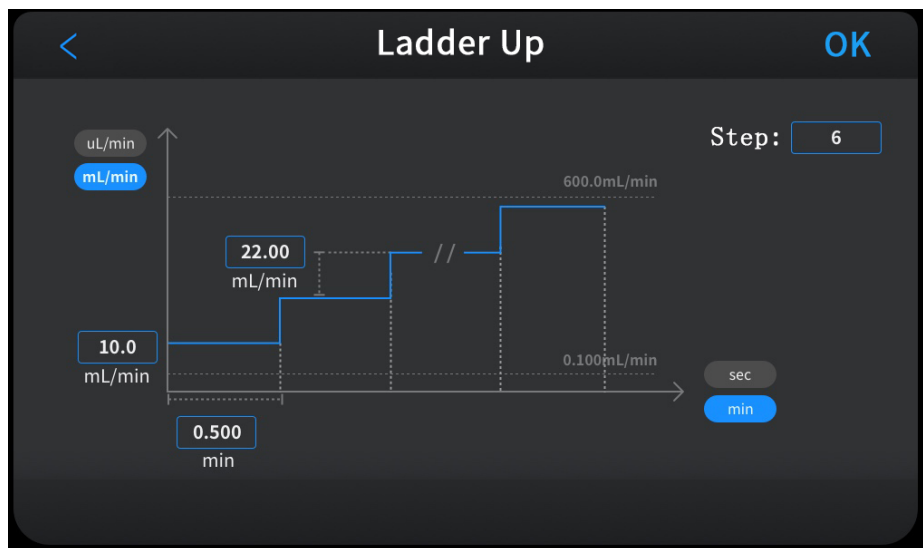

Figure 4-17

Function of stepped up module: According to the set step time, step increment and number of steps, the flow rate is gradually increased from the starting flow rate, and then the pump continues to run the next function module.

Starting flow rate: Tap the data field to enter it, the range is 0.001-9999, the unit is uL/min or mL/min, and tap the vertical axis unit to set the unit.

Step increment of flow rate: Tap the data field to enter it, the range is 0.001-9999, the unit is uL/min or mL/min, the same as the starting flow rate unit.

Number of steps: Tap the data field to enter it, the range is 2-99.

Step time: Tap the data field to enter it, 1sec-9000sec or 0.1min -150min. Tap the horizontal axis unit to set the unit.

Flowrange indicator value: The maximum and minimum flow rate that can be supported according to the specifications of the currently set pump head and tubing. A prompt will be given when the value entered is out of limit.

Note:

Minimum flowrate \leq Starting flow rate $<$ Maximum flow rate

The ending flow rate calculated according to the starting flow rate, step increment, and number of steps shall be less than or equal to the maximum flow rate.

Tap the "<" key at the top left of the screen to return to the module selection screen. Tap the "OK" key at the top right of the screen to save the current module parameters and return to the method parameter editing screen.

4.3.4.5 Parameter Setting of Stepped Down Module

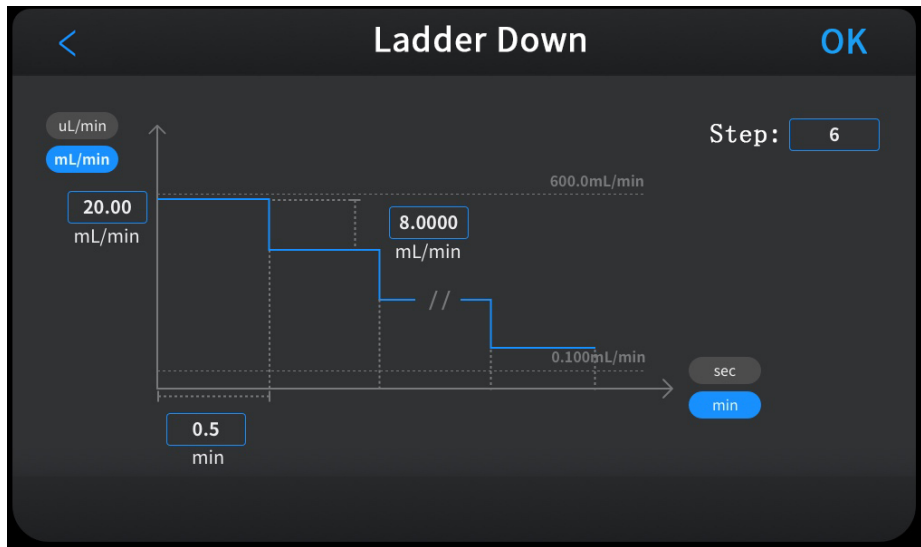

Figure 4-18

Function of stepped down module: According to the set step time, step decrement and number of steps, the flow is gradually decreased from the starting flow rate, and then the pump continues to run to the next function module.

Starting flow rate: Tap the data field to enter it, the range is 0.001-9999, the unit is uL/min or mL/min, and tap the vertical axis unit to set the unit.

Step decrement: Tap the data field to enter it, the range is 0.001-9999. Unit: uL/min or mL/min, the same as the initial flow unit.

Number of steps: Tap the data field to enter it, the range is 2-99.

Step time: Tap the data field to enter it, 1sec-9000sec or 0.1min -150min. Tap the horizontal axis unit to set the unit.

Flowrange indicator value: The maximum and minimum flow rate that can be supported according to the specifications of the currently set pump head and tubing. A prompt will be given when the value entered is out of limit.

Note:

Minimum flow rate < Starting flow rate <= Maximum flow rate

The ending flow calculated according to the starting flow, step increment, and number of steps shall be greater than or equal to the minimum flow rate.

Tap the "<" key at the top left of the screen to return to the module selection screen. Tap the "OK" key at the top right of the screen to save the current module parameters and return to the method parameter editing screen.

4.3.4.6 Parameter Setting of Constant Dispensing Module

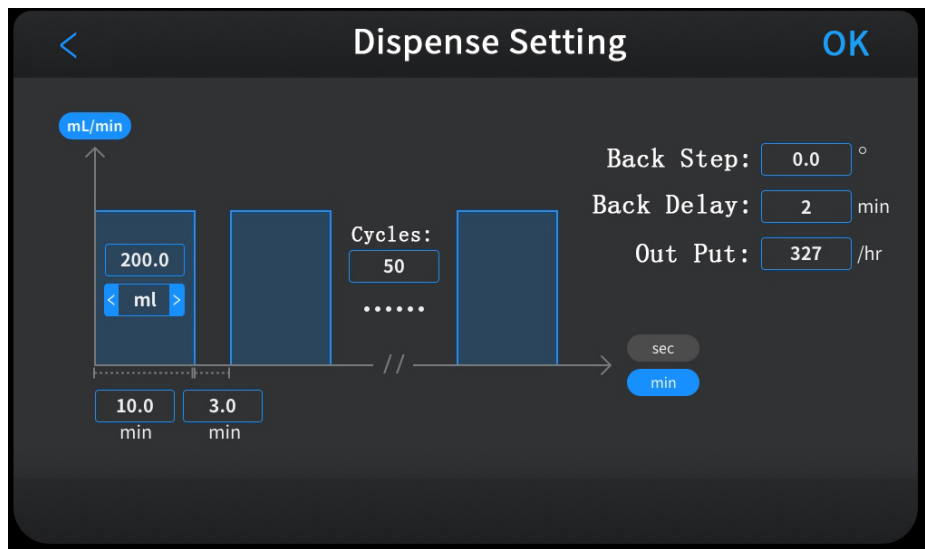

Figure 4-19

Function of constant dispensing module: It performs constant dispensing according to the set dispensing volume, number of dispensing cycles, dispensing time and interval time. After the dispensing is completed, the pump continues to run the next function module.

Dispensing volume: Tap the data field to enter it, the range is 0.001-9999. Dispensing volume unit: uL, mL, L, tap the liquid volume unit to set the unit.

Dispensing cycles: Tap the data field to enter it, the range is 1-999999, 0 means unlimited.

Dispensing time: Tap the data field to enter it, 0.5sec-9000sec or 0.1min-150min. Tap the horizontal axis unit to set the unit.

Interval time: Tap the data field to enter it, 0.5sec-9000sec or 0.1min-150min. The unit is the same as the dispensing time unit.

Filling output: 1-3600 cycles/hour.

Back suction angle: 0-999 degrees.

Back suction delay: 0-60 sec, adjustment resolution: 0.01sec

Note:

1. The dispensing time includes the back suction delay time and the back suction angle running time, and if the time exceeds the limit, an alarm will be issued.
2. It is only needed to select any two of the three parameters of filling output, dispensing time and interval time for input, and the third parameter will be calculated automatically.

Tap the "<" key at the top left of the screen to return to the module selection screen. Tap the "OK" key at the top right of the screen to save the current module parameters and return to the method parameter editing screen.

4.3.4.7 Parameter Setting of Incremental Dispensing Module

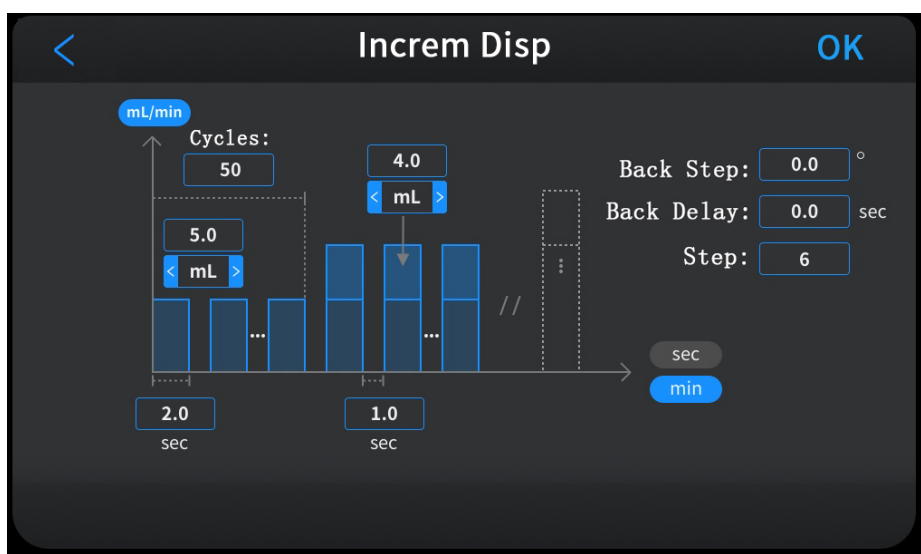

Figure 4-20

Function of incremental dispensing module: According to the number of steps and step increment, the dispensing volume to be dispensed is gradually increased. After the dispensing is completed, the pump continues to run the next function module.

Starting dispensing volume: Tap the data field to enter it, the range is 0.001-9999. Liquid volume unit: uL, mL, L, tap the liquid volume unit to set the unit.

Step increment of liquid volume: Tap the data field to enter it, the range is 0.001-9999. Liquid volume unit: uL, mL, L, tap the liquid volume unit to set the unit.

Dispensing cycles: Tap the data field to enter it, 1-999999 times, 0 means unlimited times.

Dispensing time: Tap the data field to enter it, 0.5-9000sec or 0.1min-150min. Tap the horizontal axis unit to set the unit.

Interval time: Tap the data field to enter it, 0.5-9000sec, and the unit is the same as the dispensing time unit.

Number of steps: The range is 2-99.

Back suction angle: 0-999 degrees.

Back suction delay: 0-60 sec, adjustment resolution: 0.01sec

Note:

The dispensing time includes the back suction relay time and the back suction angle running time, and if the time exceeds the limit, an alarm will be issued.

Tap the "<" key at the top left of the screen to return to the module selection screen. Tap the "OK" key at the top right of the screen to save the current module parameters and return to the method parameter editing screen.

4.3.4.8 Parameter Setting of Decremental Dispensing Module

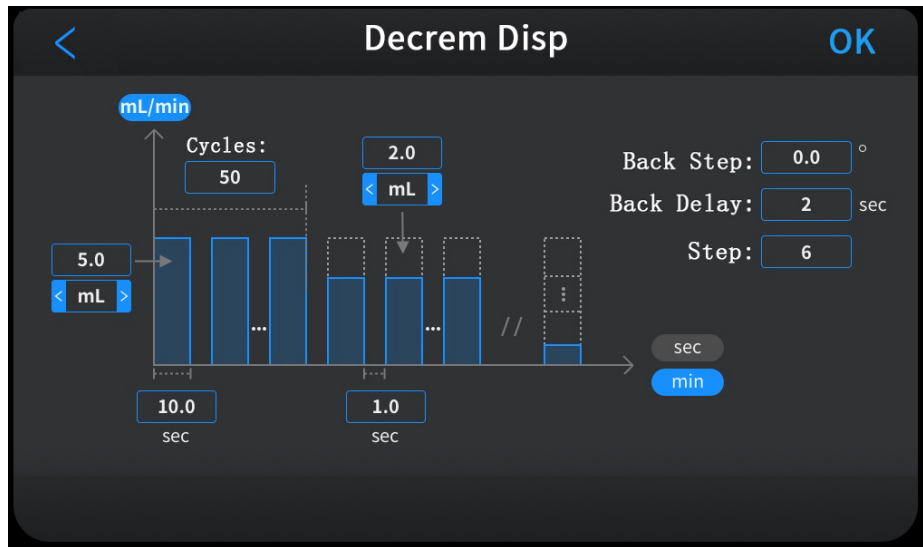

Figure 4-21

Function of decremental dispensing module: According to the number of steps and step decrement, the dispensing volume to be dispensed is gradually decreased. After the dispensing is completed, the pump continues to run the next function module.

Starting dispensing volume: Tap the data field to enter it, the range is 0.001-9999. Liquid volume unit: uL, mL, L, tap the liquid volume unit to set the unit.

Step decrement of liquid volume: Tap the data field to enter it, the range is 1-9999. Liquid volume unit: uL, mL, L, tap the liquid volume unit to set the unit.

Dispensing cycles: Tap the data field to enter it, 0 or 1-999999 times, 0 means unlimited times.

Dispensing time: Tap the data field to enter it, 0.5-9000sec or 0.1min-150min. Tap the horizontal axis unit to set the unit.

Interval time: Tap the data field to enter it, 0.5-9000sec. The unit is the same as the dispensing time unit.

Step number: Tap the data field to enter it, the range is 2-99.

Back suction angle: 0-999 degrees.

Back suction delay: 0-60 sec.

Note:

The dispensing time includes the back suction relay time and the back suction angle running time, and if the time exceeds the limit, an alarm will be issued.

Tap the "<" key at the top left of the screen to return to the module selection screen. Tap the "OK" key at the top right of the screen to save the current module parameters and return to the method parameter editing screen.

4.3.4.9 Parameter Setting of Sine Curve Module

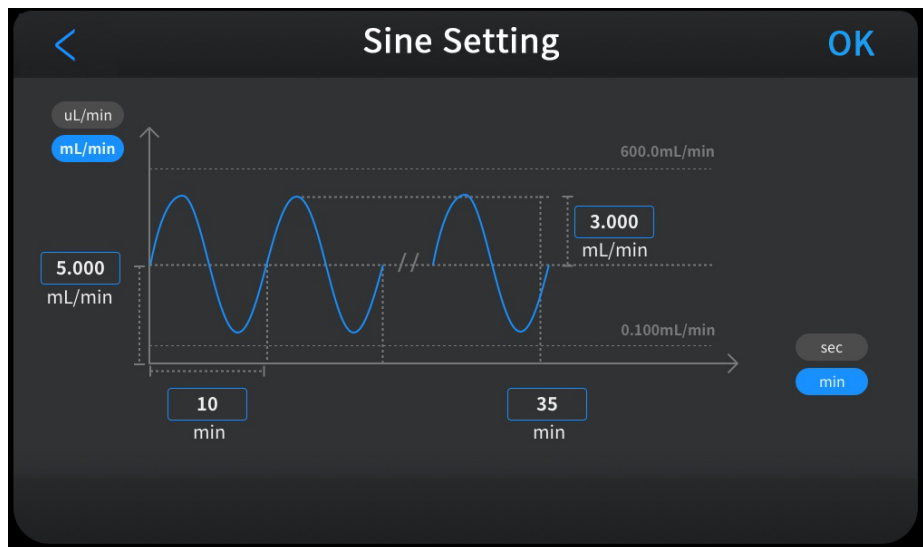

Figure 4-22

Function of sine curve module function: According to the set offset, amplitude, cycle time and running time, the flow rate of the pump changes according to the sine curve. Then the pump continues to run the next function module.

Offset: The distance by which the sine wave's midpoint is offset from the 0 point. Tap the data field to enter it, the range is 0.001-9999, the unit is uL/min or mL/min, and tap the vertical axis unit to set the unit.

Amplitude: The distance from the peak of the sine wave to the midpoint. Tap the data field to enter it, the range is 0.001-9999, the unit is uL/min or mL/min, the same as the offset unit.

Cycle time: Tap the data field to enter it, 5-9000sec. The cycle time is not less than 5s.

Running time: 1sec-9000sec or 0.1min-150min. Tap the horizontal axis unit to set the unit.

Flowrange indicator value: The maximum and minimum flow rate that can be supported according to the specifications of the currently set pump head and tubing. A prompt will be given when the value entered is out of limit.

Note:

Minimum flow rate \leq offset - amplitude

Offset + amplitude \leq maximum flow rate

Tap the "<" key at the top left of the screen to return to the module selection screen. Tap the "OK" key at the top right of the screen to save the current module parameters and return to the method parameter editing screen.

4.3.4.10 Parameter Setting of Direction Module

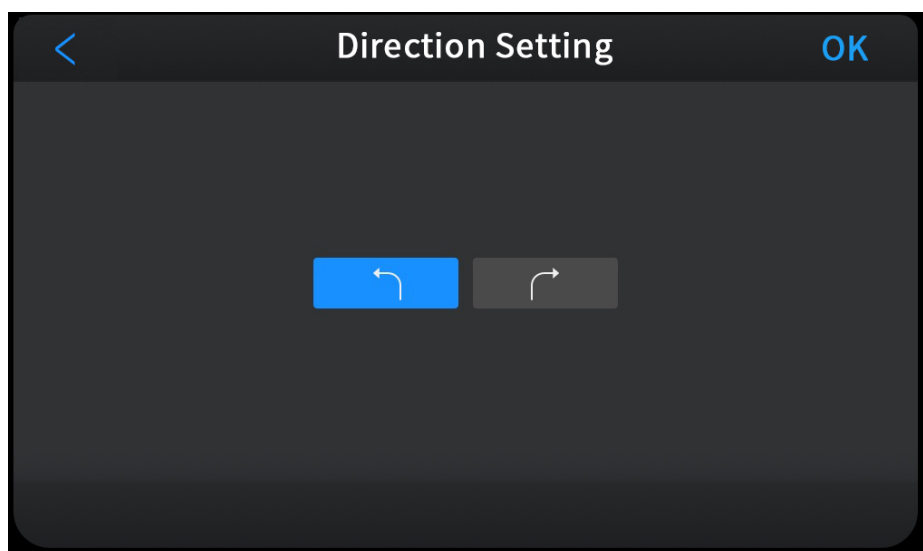

Figure 4-23

Set the running direction of the pump to clockwise or anticlockwise through the direction module.

Tap the "<" key at the top left of the screen to return to the module selection screen. Tap the "OK" key at the top right of the screen to save the current module parameters and return to the method parameter editing screen.

When there is no direction module in the parameter method, the running direction of the pump is clockwise by default.

4.3.4.11 Parameter Setting of Pause Module

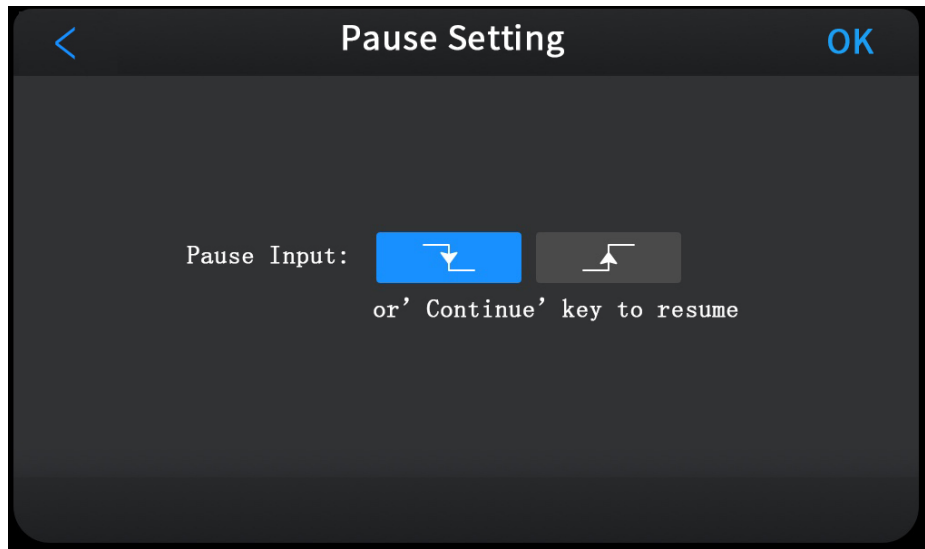





Figure 4-24

Through the pause module, the pump can be temporarily stopped during operation. You can end the pause state by inputting an external trigger signal into the pump, or manually pressing the "Continue" button that appears on the running screen, and continue to execute the next steps in the method.

On the parameter setting screen of the pause module, you can set the type of external signal for terminating the pause state. "" indicates a falling edge trigger, that is, when the input signal changes from a high level to a low level, the pause state is terminated. "" indicates a rising edge trigger, that is, when the input signal changes from a low level to a high level, the pause state is terminated. The terminal that receives this external signal is the Pin 7 of Control Input Interface 5, please refer to Chapter5.4.

Tap the "<" key at the top left of the screen to return to the module selection screen. Tap the "OK" key at the top right of the screen to save the current module parameters and return to the method parameter editing screen.

The screen when the pump enters the pause state during operation is shown in the figure below, you can tap "" to terminate the pause state and continue to execute the next step.

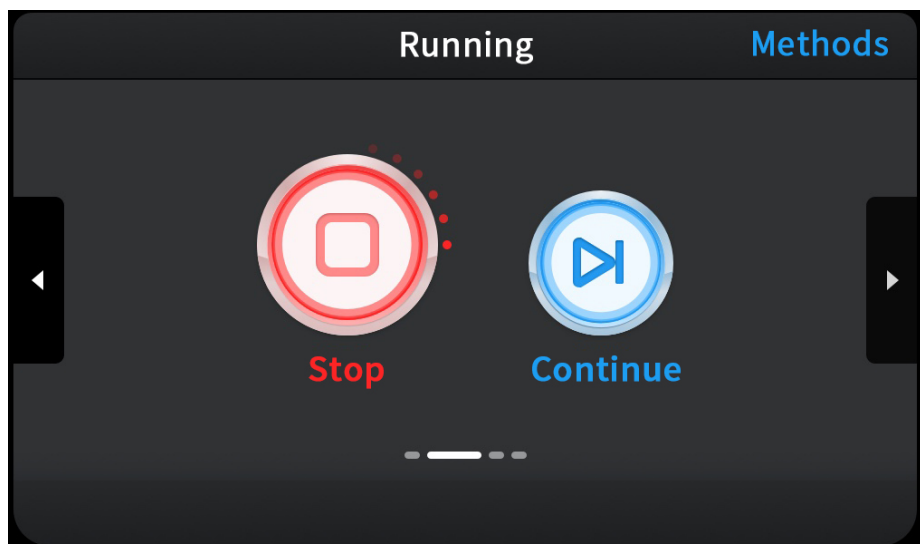

Figure 4-25

4.3.4.12 Parameter Setting of Delay Module

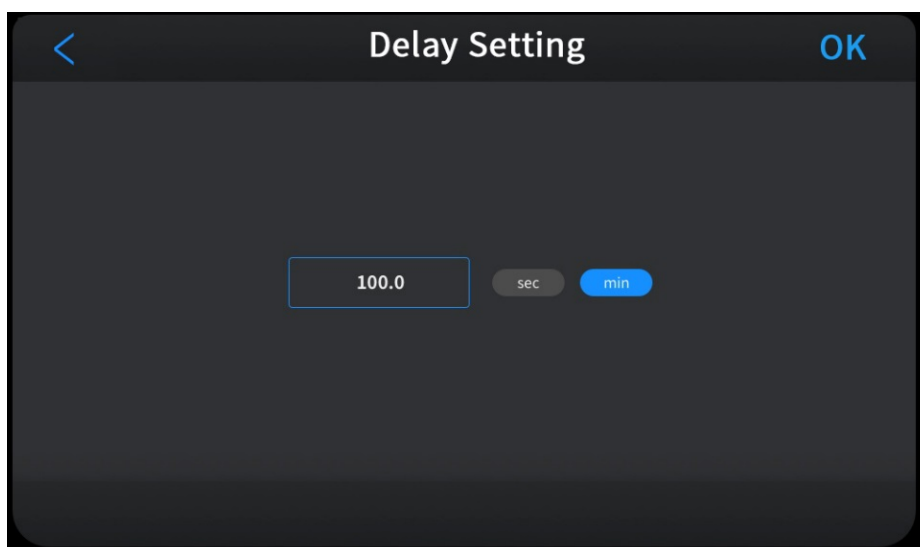

Figure 4-26

Through the delay module, the pump is temporarily stopped for a period of time during the running process, and the pause time is the time set in the delay module. When the set time is reached, the pump will automatically continue to execute the next steps in the method.

The delay time range: 0.5sec-9000sec (150min)

Time unit: sec, min, tap the unit to set. The time parameter will change automatically after switching the unit.

Tap the "<" key at the top left of the screen to return to the module selection screen. Tap the "OK" key at the top right of the screen to save the current module parameters and return to the method parameter editing screen.

4.3.4.13 Parameter Setting of Event Trigger Module

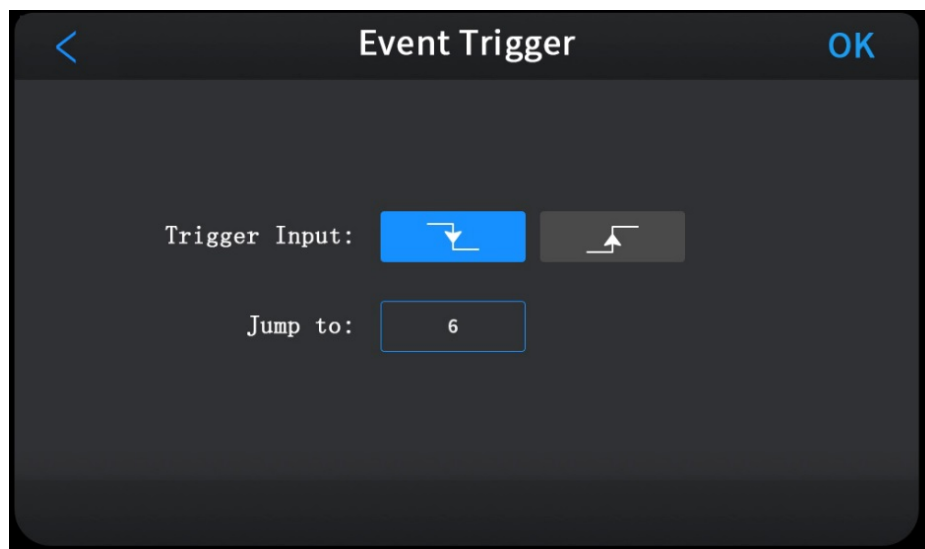

Figure 4-27

If an event trigger module is used in the method, when it comes to reaching this step, the method continues to execute subsequent steps. After that, when the corresponding input terminal of the pump receives the set trigger signal, the pump will immediately stop the current operation (including the loop), and instead, execute the jump step set in the event trigger module.

The entire method allows only one event trigger step, the trigger event is a single trigger (after the event trigger jump is executed once, when the corresponding terminal receives the trigger signal again, the pump no longer performs the jump operation), it can jump to any step, and after executing the jump, all loops exit.

The terminal that receives this external signal is the Pin 2 of Control Input Interface 5, please refer to Chapter 5.4.

Note:

Before the event trigger module is executed, if the pump receives a trigger signal, the jump operation is not performed.

Tap the "<" key at the top left of the screen to return to the module selection screen. Tap the "OK" key at the top right of the screen to save the current module parameters and return to the method parameter editing screen.

4.3.4.14 Parameter Setting of External Output Module

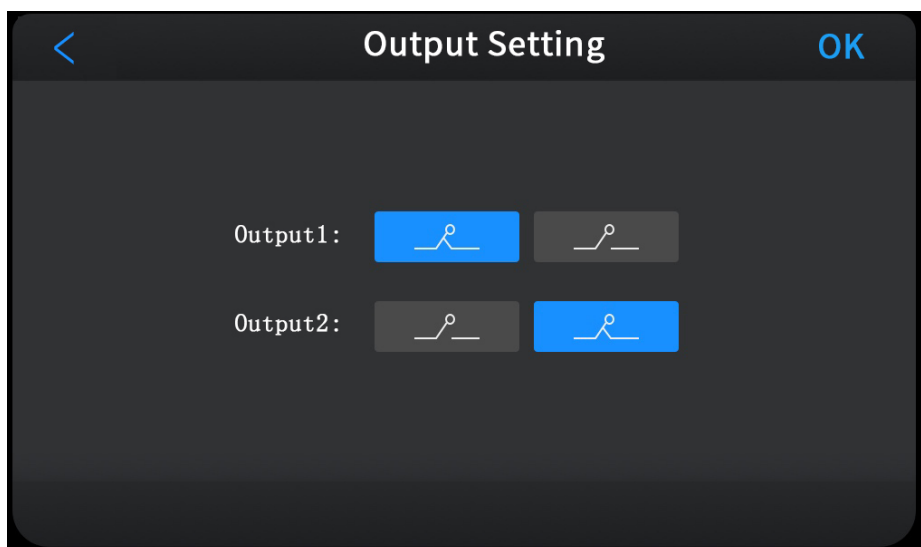

Figure 4-28

If an external control output module is used in the method, when it comes to reaching this step, the pump will output OC gate signal at the corresponding output terminal, and the transistor will be on or off according to the parameter set in the module. The pump provides two output signals: External Output 1, External Output 2, and please refer to Chapter 5.5 for the definition of output terminals.

The OC gate signal is off by default after power-on.

When use the OC gate signals, the pull-up resistor and pull-up power supply need to be connected to the corresponding output terminals.

Tap the "<" key at the top left of the screen to return to the module selection screen. Tap the "OK" key at the top right of the screen to save the current module parameters and return to the method parameter editing screen.

4.3.4.15 Parameter Setting of Jump Module

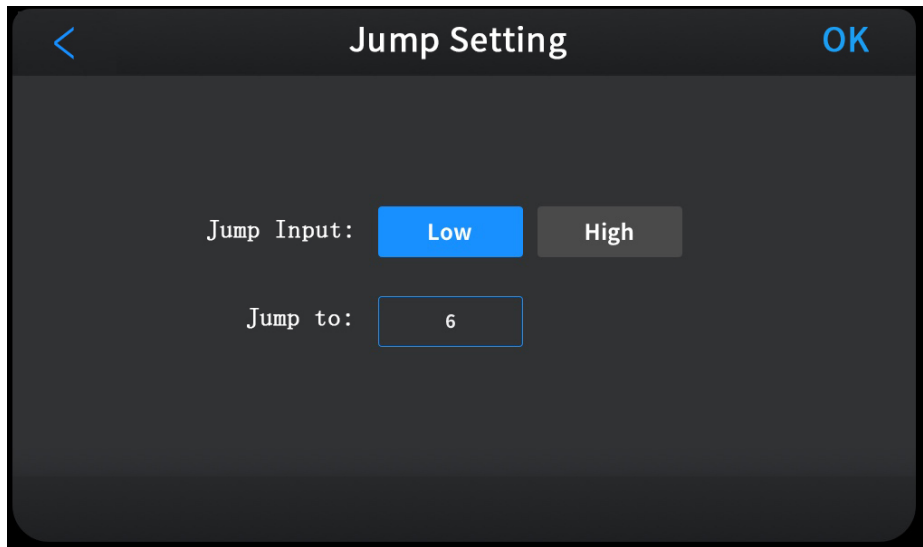

Figure 4-29

If a jump module is used in the method, when it comes to reaching this step, and the corresponding input terminal of the pump receives a set high level or low level signal, the pump will immediately stop the current operation and go to execute the set jump step in the jump module. If there is no set signal at the corresponding input terminal, the pump will continue to perform the next steps, and the jump module will not be executed any more.

The terminal that receives this external signal is the Pin 6 of Control Input Interface 5, please refer to Chapter 5.4.

Note: It is only allowed to jump backwards and not allowed to jump out of the current loop.

Trigger signal type: High level signal and low level signal

Tap the "<" key at the top left of the screen to return to the module selection screen. Tap the "OK" key at the top right of the screen to save the current module parameters and return to the method parameter editing screen.

4.3.4.16 Parameter Setting of Loop Module

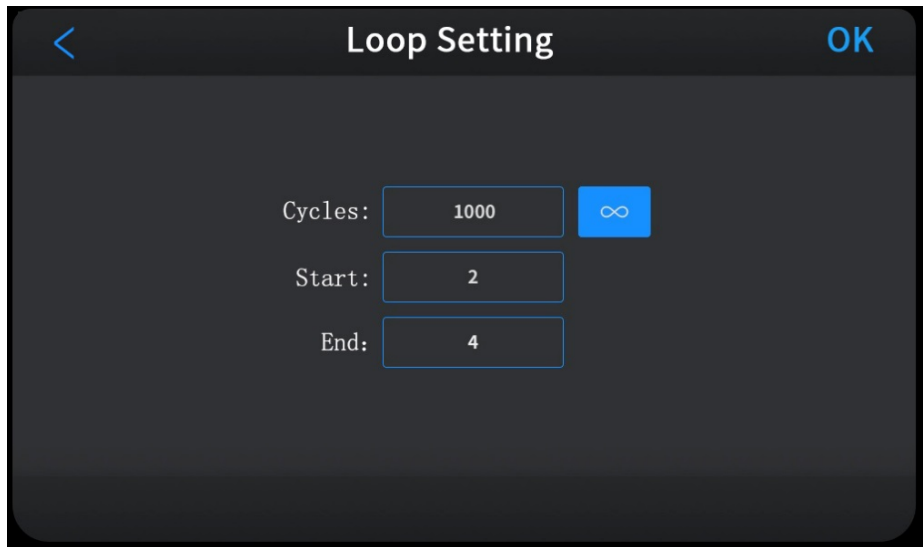

Figure 4-30

In the method, the loop module is used to repeatedly execute some steps in sequence (from the start step to the end step), and the cycle number of loops can be set, or it can be set as unlimited loop.

When reaching the loop step, it will automatically jump to the start step of the loop and start to execute the steps in the loop operation in sequence until the set cycle number of loops is completed. When the infinite loop is set, it is needed to use the event trigger function to jump out of the loop step.

The start step must be smaller than the end step.

Number of loops: 1-1000, 0 indicates infinite loop

Tap the "<" key at the top left of the screen to return to the module selection screen. Tap the "OK" key at the top right of the screen to save the current module parameters and return to the method parameter editing screen.

4.3.4.17 Parameter Setting of End Module

The end step has no parameters. It represents the termination step of a method.

4.4 Calibration

After the pump powers up, it enters the standby screen, tap the "▶" key to switch to the

calibration screen.

There are two calibration methods, volume calibration and weighing calibration. Please choose the methods as needed.

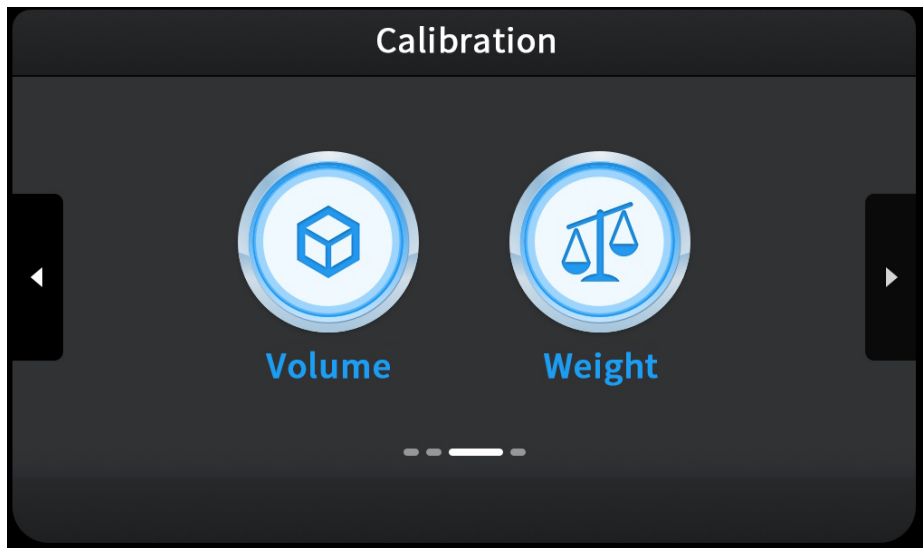

Figure 4-31

4.4.1 Volume Calibration



Figure 4-32

If only volume measuring instruments are available, such as graduated cylinders, please choose the volume calibration methods.

After pressing the "Start" key, the pump starts to transfer fluid, and the screen is displayed as shown in the figure below.

When the first running module is not constant dispensing module, the theoretical volume

(target volume) will be automatically calculated based on the testing time, and the displayed value will change with the time. When the fluid volume reaches the required volume, press the "Stop" key to complete the fluid transferring.

When the first running module is the constant dispensing module, the pump will run according to the set dispensing time, and it will stop automatically when the dispensing time is reached. Then the target volume will display the dispensing volume set in the constant dispensing module.



Figure 4-33

When the pump stops running, read the actual volume transferred during this period and enter it into the data field of "Actual Volume". The "Calibrate" key will then light up and be enabled.



Figure 4-34

Tap the "Calibrate" key, the following dialog box will pop up.

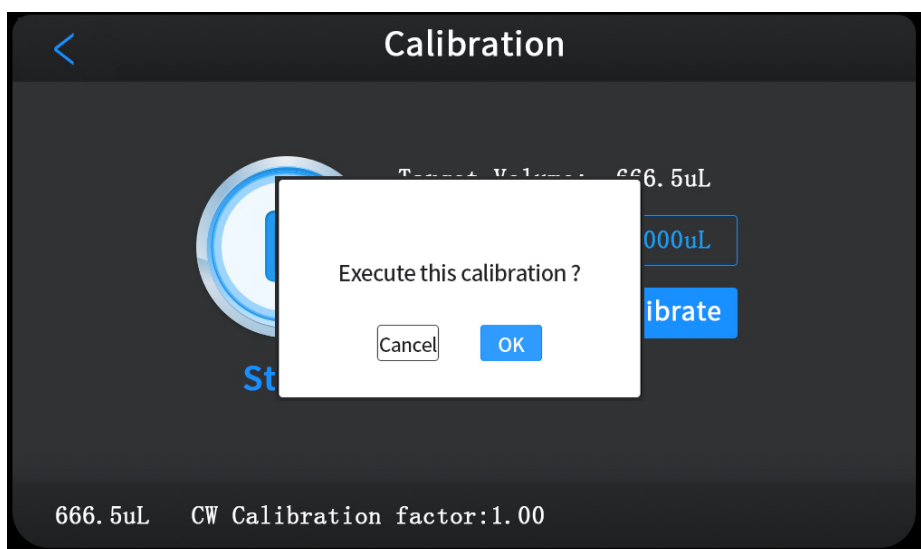

Figure 4-35

Press the "OK" key to complete the calibration process, and meanwhile, the prompt bar at the bottom of the screen also displays information as "Setting Saved".

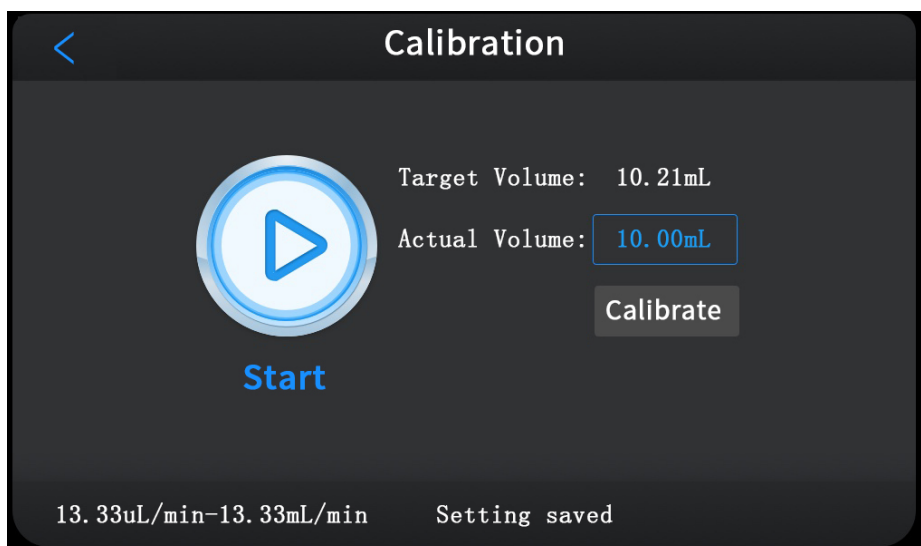

Figure 4-36

If the current method is out of limit after calibration, the following alarm prompt will pop up. There are two options, "Cancel Calibration" and "Calibrate and Enter Method Editing".

Tap "Calibrate and Enter Method Editing" to enter the method editing screen, then modify the

step with parameters out of limit.

Tap “Cancel” to cancel this calibration operation.

Note:

In case that the first running module is the constant speed module, the pump will be calibrated according to the set flow rate in the constant speed module.

In case that the first running module is the constant dispensing module, the pump will be calibrated according to the set dispensing volume and time in the constant dispensing module.

In other cases, the pump will be calibrated according to the flow rate corresponding to half of the maximum speed of the pump.

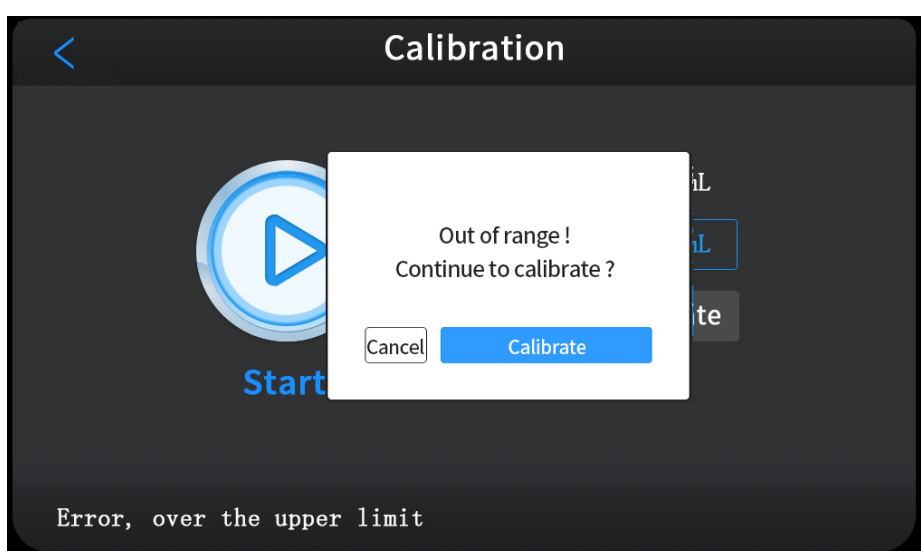

Figure 4-37

4.4.2 Weighing Calibration

The operation of weighing calibration is the same as that of volume calibration. This method is more recommended for users with precision balances, and the calibration results are more accurate. Please refer to Chapter 4.4.1 for other details.

Note:

The default density of the liquid is 1g/cm³, and in order to make the fluid volume more accurate during weighing calibration, it is needed to set the density firstly in the method configuration screen.



Figure 4-38

4.5 System Parameter Settings

From the standby screen, tap "▶" twice to switch to the system parameter setting screen. Tap the icon to enter the parameter setting screen. The system settings include six sub-screens: foot switch setting, communication setting, external control setting, language setting, factory reset, and product information. You can switch between different screens using the "▶" and "◀" on the two sides of the screen.

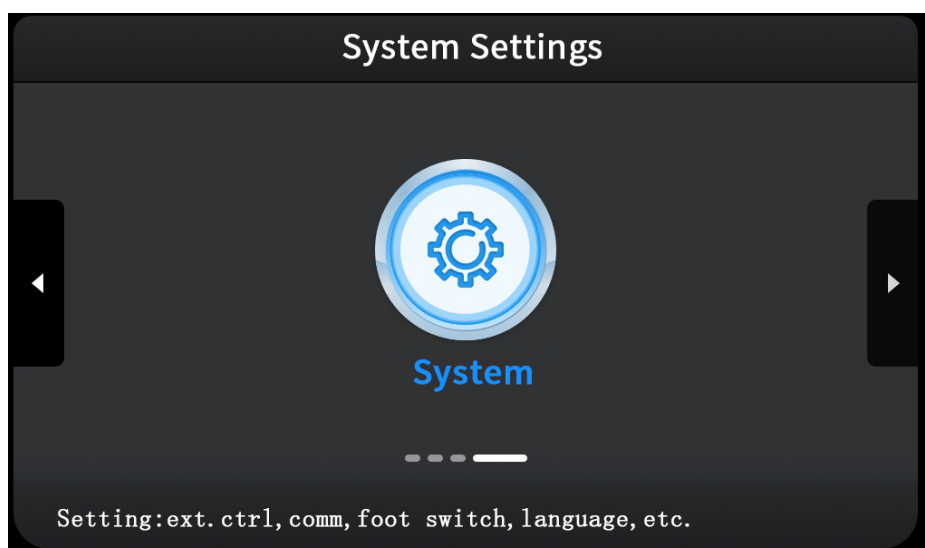

Figure 4-39

4.5.1 Foot Switch Setting



Figure 4-40

If you need to use the foot switch to control the start and stop of the pump, you can set the control logic on this screen.

There are four options for the control logic: Down-run, Up-run, Up-change, and Disabled.

Down-run: When the foot switch is pressed, the pump runs, and when the foot switch is unpressed, the pump stops.

Up-run: When the foot switch is pressed, the pump stops, and when the foot switch is unpressed, the pump runs.

Up-change: Pressing and unpressing once is a valid signal, which means switching between running and stopping.

Disabled: The foot switch control is invalid.

Tap the "<" key at the top left of the screen to return to the system setting interface. Tap the "OK" key at the top right of the screen to save the current parameters.

Note:

1. When it is needed to use the foot switch to control the pump, the Parameter Method 6 or Parameter Method 7 should be selected.
2. When the foot switch is used to control the start and stop of the pump, the "Run" icon on the standby screen is invalid.

4.5.2 Communication Setting

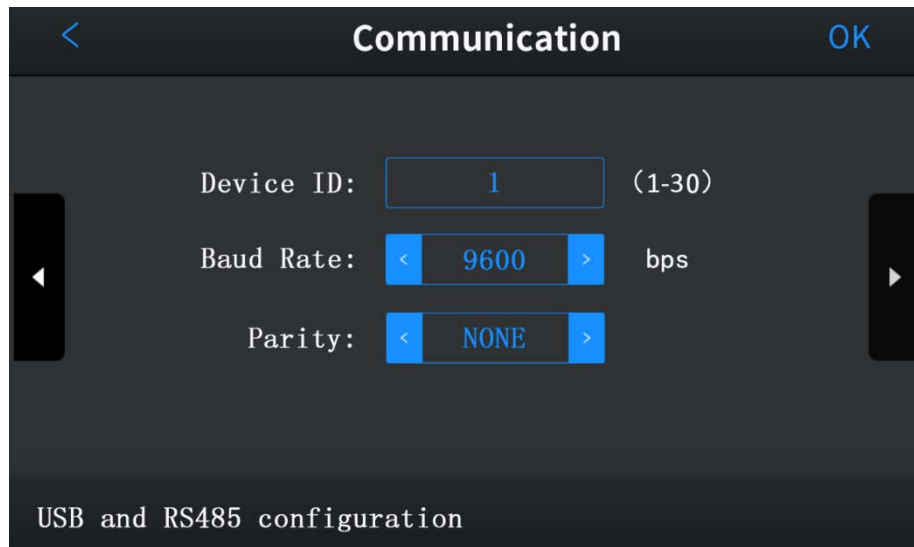

Figure 4-41

When the pump is controlled by communication commands, the parameters that need to be set are: pump address, baud rate, and parity.

Pump address (Device ID): could be set as 1-32.

Baud rate: 1200bps, 2400bps, 4800bps, 9600bps, 19200bps, 38400bps.

Parity: EVEN, ODD, NONE.

Tap the "<" key at the top left of the screen to return to the system setting interface. Tap the "OK" key at the top right of the screen to save the current parameters.

4.5.3 External Control Setting

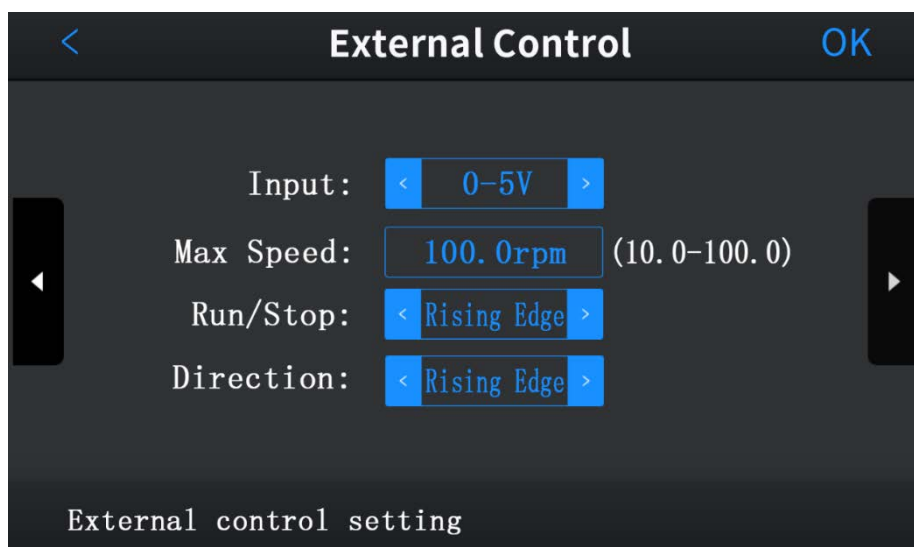

Figure 4-42

When external signals are used to control the start/stop, direction, and pump speed, the parameters that need to be set are: type of speed control signal, maximum pumpspeed corresponding to the maximum external control signal, type of start control signal, and type of direction control signal.

Input signal: It is control signal for pumpspeed, and there are four options: 0-5V / 0-10V / 4-20mA / 0-10KHz.

Maxspeed: the max speed corresponding to the maximum external speed control signal.

Set range:

Pump model	L100-1F/L100-1FS	L300-1F/L300-1FS	L600-1F/L600-1FS
Max speed set range	10-100(rpm)	30-300(rpm)	60-600(rpm)

Run/Stop: signal to start the pump: Rising Edge, Falling Edge, Low Level, High Level.





Direction: signal to control pump running direction: Rising Edge, Falling Edge, Low Level, High Level.

Tap the "<" key at the top left of the screen to return to the system setting interface. Tap the "OK" key at the top right of the screen to save the current parameters.

Note:

1. When it is needed to use external signals to control the pump, the Parameter Method 8 should be selected.
2. Please refer to Chapter 5.4 for the relationship between the signal types of run/stop control and direction control and the control logics of the pump.

4.5.4 Language Setting

Switch to the language setting screen by tapping " or ", as shown in the figure below. There are two options: Chinese and English. Tap the "<" key at the top left of the screen to return to the system setting screen. Tap "OK" or ""/" to save the current language setting.

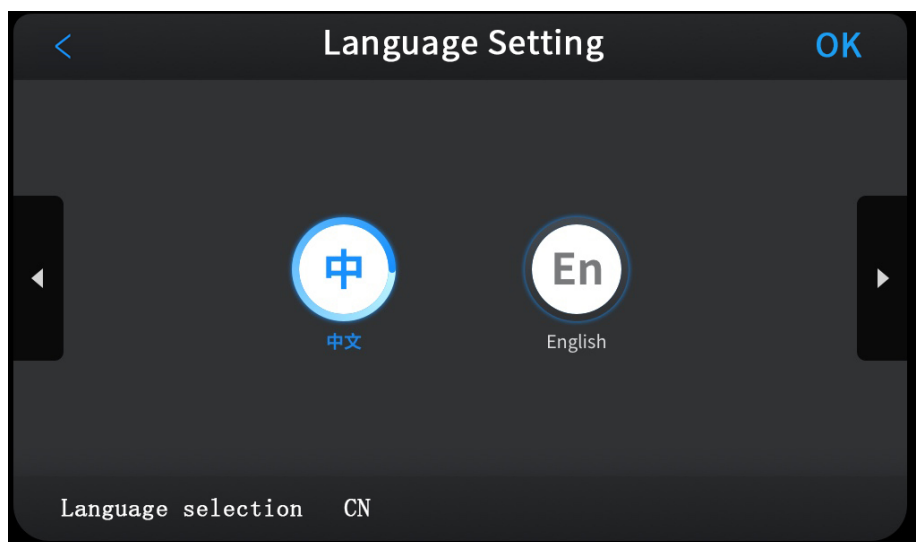

Figure 4-43

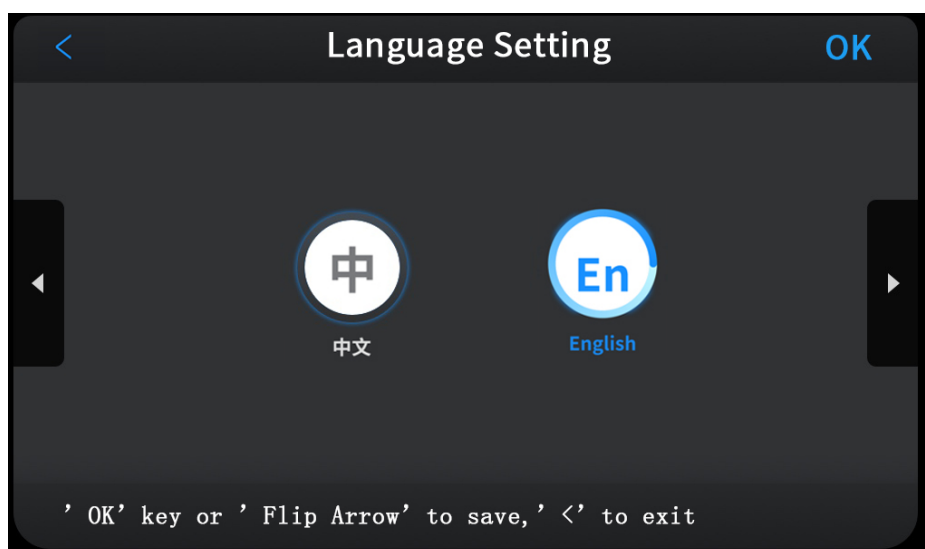

Figure 4-44

4.5.5 Factory Reset

Switch to the factory reset screen by tapping "▶" or "◀", as shown in the figure below. If you choose to restore the factory settings, all user settings will be restored to the default values, so please operate carefully.

Tap the "<" key at the top left of the screen to return to the system setting screen.

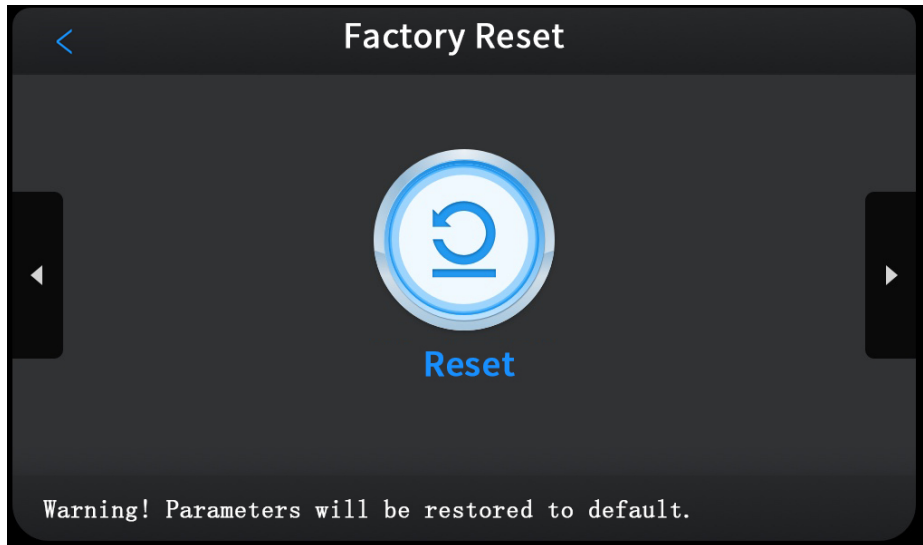

Figure 4-45

4.5.6 Product Information

Product information includes the product model, software version, and hardware version. The scanning the QR code to link to Longer's official WeChat account for learning more about the product.

Tap the "<" key at the top left of the screen to return to the system setting screen.

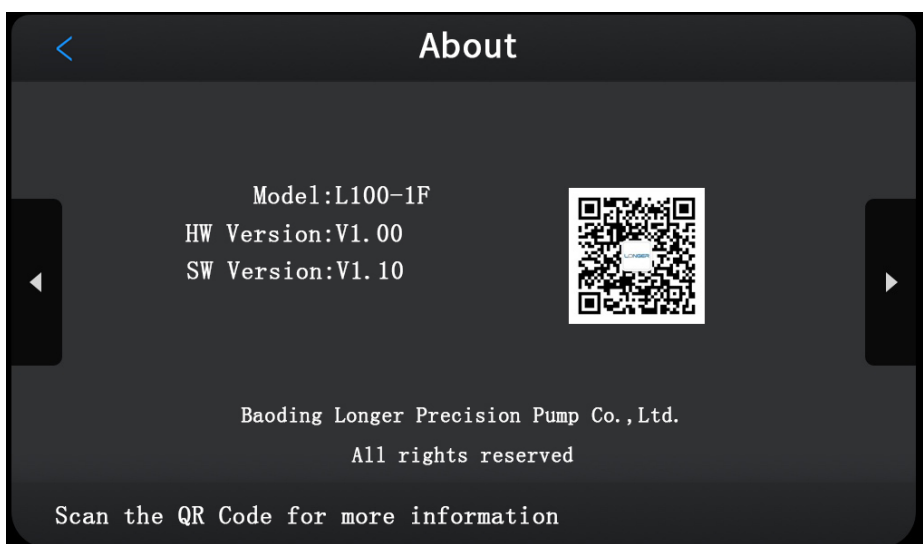
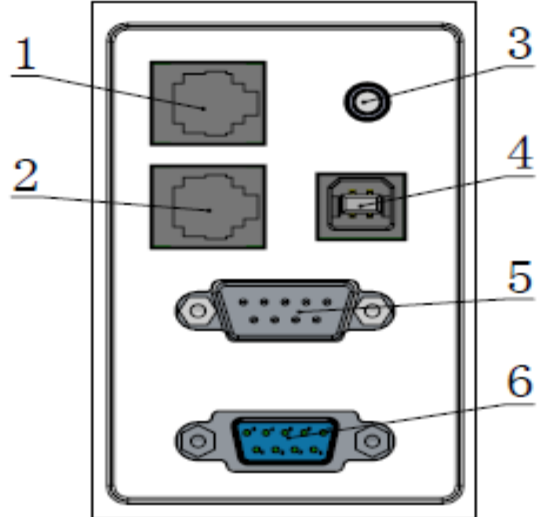

Figure 4-46

5 External Control

The pump is equipped with a broad range of external control interfaces, with two RJ11 interfaces as RS485 communication interfaces (Interface 1, Interface 2); one headset-jack interface as foot switch interface (Interface 3); one USB-B interface as USB serial bus communication interface (Interface 4); one DB9-M (Interface 5) and one DB9-F (Interface 6) as interfaces for external control signals and status input and output.

Description of external control interface panel	
No.	Designation
Interface 1	RS485 interface
Interface 2	RS485 interface
Interface 3	Foot switch interface
Interface 4	USB communication interface
Interface 5	External control input interface
Interface 6	External control output interface



5.1 Communication Control

The intelligent peristaltic pump provides two RS485 interfaces and one serial USB interface to complete the interconnection with the remote controller. The remote controller control the pump by sending communication commands to the pump. The pump supports Modbus RTU protocol. The communication parameters need to be set before communication control, including pump address (RS485), baud rate, and parity.

Pump address: could be set as 1-32.

Baud rate: 1200bps, 2400bps, 4800bps, 9600bps, 19200bps, 38400bps.

Parity: EVEN, ODD, NONE.

5.1.1 RS485 Communication (Interface 1, Interface 2)

The pump has two RS485 interfaces, and the two interfaces are connected in parallel: they can be used as the input interface for the remote controller to control the pump and can also be used as the output interface interconnected with other pumps. The interface form is RJ11 (6-core telephone line plug). The communication control is realized through RS485 input interface without installing a driver. The interface definition is as follows:

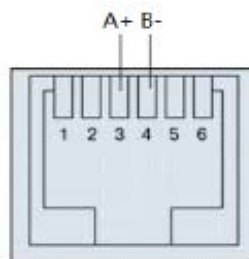

RS485 interface

5.1.2 USB Communication (Interface 4)

The serial communication control by PC can be realized through USB-B interface. It is needed to connect to the PC (Windows 7 and above) via the cable, and install the corresponding driver.

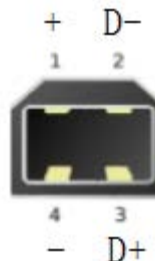

USB interface

5.1.3 MODBUS RTU Protocol

Address segment type	Register address	Register name	Write	Read	Meaning
Control register segment	0x0000	Start/stop control		Last written value	0: Stop, 1: Run;
	0x0001	Fast forward control		Last written value	0: Stop, 3: Full speed forward;
	0x0002	Fast backward control		Last written value	0: Stop, 2: Full speed backward;
	0x0010	Work mode	3	Last written value	3: Program Mode;
	0x0011	Method number	0-MAX_Pro	Last written value	For intelligent pumps, this address is valid when "Work mode" was set as 3.
Configuration parameter register segment	0x0040	Pump head model		Current setting value	Refer to 5.1.4 for pump head defining range.
	0x0041	Tube model		Current setting value	Refer to 5.1.5 for Tube defining range
	0x0042	Fluid coefficient		Current setting value	When work mode > 0, it is valid; when work mode = 3, it changes with "method number". Value range: 100-1000; value 100 corresponds to fluid coefficient of 1, and value 1000 corresponds to fluid coefficient of 10; For example, for fluid coefficient 1.1, the value should be 110.
	0x0043	Fluid density		Current setting value	When work mode > 0, it is valid; when work mode = 3, it changes with "method number" Value range: 100-20000; Value 100 corresponds to a density of 0.1; Value 1000 corresponds to a density of 1; For example, for fluid density 1.05, the value should be 1050.
Other system parameter segment	0x0050	Pump address		Read only	Value range: 1-32
	0x0051	Baud rate		Read only	0: 1.2kbps, 1: 2.4kbps, 2: 4.8kbps, 3: 9.6kbps, 4: 19.2kbps, 5: 38.4kbps
	0x0052	Parity		Read only	0: ODD, 1: EVEN, 2: NONE
Status register	0x008a	Running method number		Current method number	Currently running method number

(read-only area)	0x008b	Current step number		Currently running step number	Currently running step number
Read-only configuration area	0x0118	Maximum method number (MAX_Pro)			Maximum method number of intelligent pump
	0x0119	Maximum method steps (MAX_Step)			Maximum method steps of intelligent pump

Address segment type	Register address	Register name	Write	Read	Meaning
Method programming area (accessible to intelligent pump, set the parameters of each step of the current method)	0x0140-0x015f	Program mode - Step 1		Current step parameters	Each step contains 32 words; for the data arrangement structure, please refer to the <i>Appendix Table 9</i> .
	Last+0x0020	Program mode - Step 2		Current step parameters	The same as above
	Last+0x0020	Program mode - Step 3		Current step parameters	The same as above
	Last+0x0020	Program mode - Step 4		Current step parameters	The same as above
	Last+0x0020	Program mode - Step 5		Current step parameters	The same as above
	Last+0x0020	Program mode - Step 6		Current step parameters	The same as above
	Last+0x0020	Program mode - Step 7		Current step parameters	The same as above
	Last+0x0020	Program mode - Step 8		Current step parameters	The same as above
	Last+0x0020	Program mode - Step 9		Current step parameters	The same as above

	Last+0x 0020	Program mode - Step 10		Current step parameters	The same as above
--	-----------------	------------------------------	--	----------------------------	-------------------

5.1.4 Pump Head Definition in the MODBUS RTU Protocol

Corresponding value of pump head					
No.	Pump head model	Value	No.	Pump head	Value
1	Undefined	0	11	DG15_24	10
2	DMD15_13	1	12	DG15_28	11
3	YZ1515X	2	14	DG_6	13
4	YZII15	3	15	DG_10	14
5	YZ2515X	4			
6	YZII25	5			
7	FG15_13	6			
8	FG25_13	7			
9	BZ15_13	8			
10	BZ25_13	9			

5.1.5 Tubing Definition in the MODBUS RTU Protocol

Corresponding value of tubing					
No.	Tube	Value	No.	Tube	Value
1	#13	0	26	0.76x0.86mm	25
2	#14	1	27	0.89x0.86mm	26
3	#19	2	28	0.95x0.86mm	27
4	#16	3	29	1.02x0.86mm	28
5	#25	4	30	1.09x0.86mm	29
6	#17	5	31	1.14x0.86mm	30
7	#18	6	32	1.22x0.86mm	31
8	#119	7	33	1.30x0.86mm	32
9	#120	8	34	1.42x0.86mm	33
10	#15	9	35	1.52x0.86mm	34
11	#24	10	36	1.65x0.86mm	35
12	#35	11	37	1.75x0.86mm	36
13	#36	12	38	1.85x0.86mm	37
14	0.5x0.8mm	13	39	2.06x0.86mm	38
15	1x1mm	14	40	2.29x0.86mm	39
16	2x1mm	15	41	2.54x0.86mm	40
17	3x1mm	16	42	2.79x0.86mm	41
18	0.13x0.91mm	17			
19	0.91x0.91mm	18			
20	0.25x0.91mm	19			
21	0.38x0.91mm	20			
22	0.44x0.91mm	21			
23	0.51x0.91mm	22			
24	0.57x0.91mm	23			
25	0.64x0.91mm	24			

5.2 Foot Switch Control (Interface 3)

In the foot switch control mode, the start and stop of the pump need to be controlled by a foot switch. First, select Parameter Method 6 or Parameter Method 7 (only for constant fluid transferring, and only has one constant speed step, or only for constant dispensing, and only has one constant dispensing step. The direction module can be used to set the running direction), then set the foot switch control logic parameters (refer to Chapter 4.5.1). When return to the standby screen, "Run" icon is invalid, and start/stop only can be controlled by foot switch.

There are four options for the control logic: Down-run, Up-run, Up-change, and Disabled.

Down-run: When the foot switch is pressed, the pump runs, and when the foot switch is unpressed, the pump stops.

Up-run: When the foot switch is pressed, the pump stops, and when the foot switch is unpressed, the pump runs.

Up-change: Pressing and unpressing once is a valid signal, which means switching between running and stopping.

Disabled: The foot switch control is invalid.

Table 4: Foot switch functions-effective in Method 6 and Method 7 (headset-jackinterface, the core is theGND terminal)

No.	Function	Signal type	Configuration parameter
1	Start-stop control input	Switch signal (relay contact signal)	Pressed to run; Unpressed to run; Pressed-unpressed to change; Disable the function;

5.3 External Signal Control

To control the start/ stop, direction and pumpspeed by external signals: Firstly, set the external control parameters through the system parameter editing screen, then select the Method 8 (external control method) in the parameter method. Then the pump will run according to the received external control signals.

Refer to Chapter 5.4 for definition of external signal input terminals.

Enter the setting screen for external control parameters, as below:

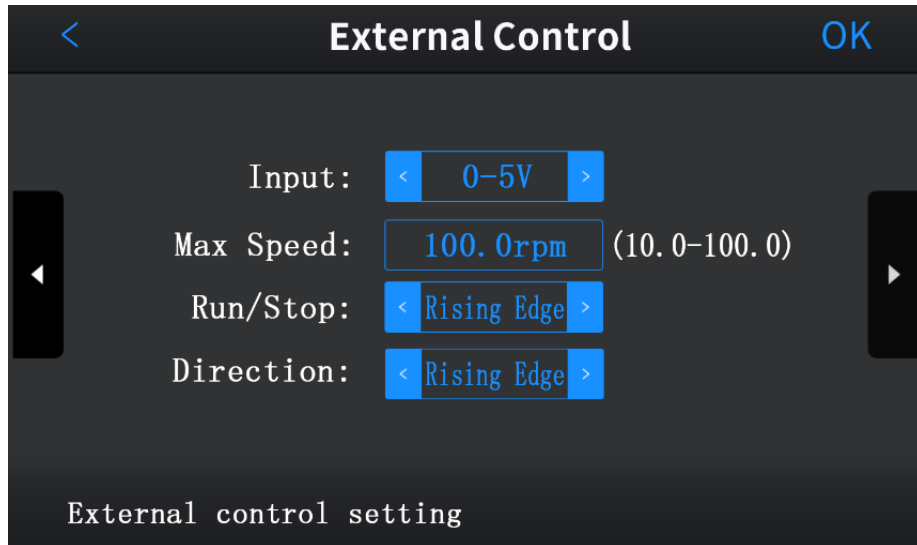

Figure 5-1

The parameters that need to be set are: type of speed control signal, maximum pump speed corresponding to the maximum external control signal, type of start control signal, and type of direction control signal.

Input signal: It is control signal for pump speed, and there are four options: 0-5V / 0-10V / 4-20mA / 0-10KHz.

Max speed: the max speed corresponding to the maximum external speed control signal.

Set range:

Pump model	L100-1F/L100-1FS	L300-1F/L300-1FS	L600-1F/L600-1FS
Max speed set range	10-100(rpm)	30-300(rpm)	60-600(rpm)

For example: The input signal is selected as 0-5V, and the maximum speed is set as 50rpm. When the input signal is 5V, the pump speed is 50rpm, and when the input signal is 3V, the pump speed is 30rpm.

Run/Stop: signal to start the pump: Rising Edge, Falling Edge, Low Level, High Level.

1. Rising Edge: pump status switches between running and stopping upon receiving a rising edge trigger signal.
2. Falling Edge: pump status switches between running and stopping upon receiving a falling edge trigger signal.
3. Low Level: pump runs when receiving a low level signal, and stops when receiving a high level signal.
4. High Level: pump runs when receiving a high level signal, and stops when receiving a low level signal.

Direction: Rising Edge, Falling Edge, Low Level, High Level.

1. Rising Edge: pump running direction switches between CW and CCW upon receiving a rising edge trigger signal.
2. Falling Edge: pump running direction switches between CW and CCW upon receiving a falling edge trigger signal.
3. Low Level: pump runs clockwise when receiving a low level signal, and runs counterclockwise when receiving a high level signal.
4. High Level: pump runs clockwise when receiving a high level signal, and runs counterclockwise when receiving a low level signal.

5.4 Definition of External Control Input Interface (Interface 5)

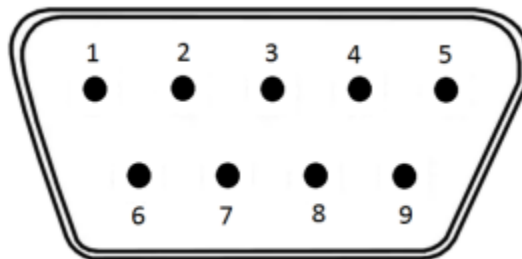

Control Input Interface (Male)

Pin 1: External start/stop control input. The start/stop control trigger mode can be set as high level-start, low level -start, rising edge-change, falling edge-change. The start/stop control signal can be logic level signal or switch signal (relay signal). Refer to Table 5.1 for details. Effective range of logic level signal: High level: 5-24V, low level $\leq 0.8V$.

Pin 3: External running direction control input. The running direction control trigger mode can be set as high level-CW, low level -CCW, rising edge-change, falling edge-change. The running direction control signal can be logic level signal or switch signal (relay signal). Refer to Table 5.2 for details. Effective range of logic level signal: High level: 5-24V, low level $\leq 0.8V$.

Pin 4: Speed control signal (4-20mA) input. Connected to 4-20mA signal +. The speed is in linear correlation with signal.

Pin 5: COM for start/stop signal, running direction signal, 0-5V/0-10V/0-10KHz speed signal,

Pin 8: Speed control signal input (0-5V, 0-10V or 0-10KHz). Connected to 0-5V, 0-10V or 0-10KHz signal +. The speed is in linear correlation with signal.

Pin 9: COM for the external speed control signal (4-20mA). Connected to 4-20mA signal -.

Pin 2: Event trigger signal input. It is used for the event trigger module, inputting external trigger logic level signal: 0-5V signal. (Refer to 4.3.4.13 Event Trigger Module for details.)

Pin 6: Jump. It is used for the jump module, inputting external trigger logic level signal: 0-5V signal. (Refer to 4.3.4.15 Jump Module for details.)

Pin 7: Pause terminating. It is used for the pause module. The pump pause state is terminated by inputting an external trigger signal (0-5V logic level signal), then the pump will continue next step operation.(Refer to 4.3.4.11 Pause Module for details.)

Note: For 0-5V logic level signal, 5V is high level, and $\leq 0.8V$ is low level.

Pin 5: COM for logic control signal: Event trigger, Jump, Pause terminating.

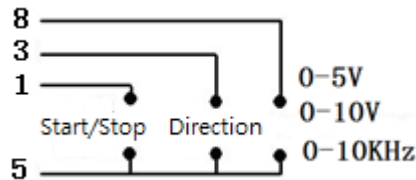

Wiring Diagram of External Control Input Interface
(Speed signal is 0-5V / 0-10V / 0-10KHz)

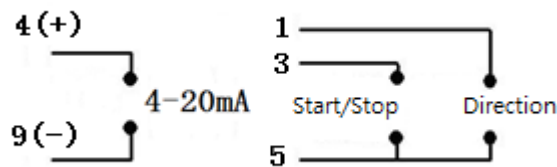

Wiring Diagram of External Control Input Interface
(Speed signal is 4-20mA)

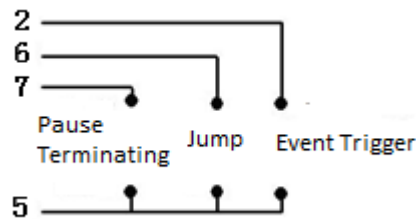

Wiring Diagram of External Control Input Interface
(Logic Control Signal)

Table 5.1 Details of external start/stop signal control (compatible with logic level signal and switch signal)

No.	Setting parameter	Input signal type	Control logic	Remarks
1	High level	Logic level signal	Pump runs at high level signal, and stops at low level signal.	1. [Pin 1] connects to signal input +, [Pin 5] connects to signal input-. 2. Effective low level signal: $\leq 0.8V$, effective high level signal: 5V-24V. 3. It is in the unstable state when the input signal voltage is between 0.8V and 5V. It may cause the malfunction of the system.
2	Low level		Pump runs at low level signal, and stops at high level signal.	
3	Rising edge		Pump status switches between running and stopping upon receiving a rising edge trigger signal.	
4	Falling edge		Pump status switches between running and stopping upon receiving a falling edge signal.	
5	High level	Switch signal (relay signal)	The pump runs when the relay contact is opened, and stops when the contact is closed.	[Pin 1] and [Pin 5] of the external control interface are respectively connected to the two leads of the switch (relay).
6	Low level		The pump runs when the relay contact is closed, and stops when the contact is opened.	
7	Rising edge		Pump status switches between running and stopping when the relay signal changes from closed to opened	
8	Falling edge		Pump status switches between running and stopping when the relay signal changes from opened to closed	

Table 5.2 Details of external direction signal control (compatible with logic level signal and switch signal)

No.	Setting parameters	Input signal type	Control logic	Remarks
1	High level	Logic level signal	Pump runs clockwise at high level signal, and counterclockwise at low level signal.	1. [Pin 3] connects to signal input +, [Pin 5] connects to signal input-. 2. Effective low level signal: $\leq 0.8V$, effective high level signal: 5V-24V. 3. It is in the unstable state when the input signal voltage is between 0.8V and 5V. It may cause the malfunction of the system.
2	Low level		Pump runs clockwise at low level signal, and counterclockwise at high level signal.	
3	Rising edge		Pump status switches between CW and CCW upon receiving a rising edge trigger signal.	
4	Falling edge		Pump status switches between CW and CCW upon receiving a falling edge trigger signal.	
5	High level	Switch signal (relay signal)	The pump runs clockwise when the relay contact is opened, and runs counterclockwise when the contact is closed.	[Pin 3] and [Pin 5] of the external control interface are respectively connected to the two leads of the switch (relay).
6	Low level		The pump runs counterclockwise when the relay contact is opened, and runs clockwise when the contact is closed.	
7	Rising edge		Pump running direction switches between CW and CCW when the relay signal changes from closed to opened.	
8	Falling edge		Pump running direction switches between CW and CCW when the relay signal changes from opened to closed.	

5.5 Definition of External Control Output Interface (Interface 6)

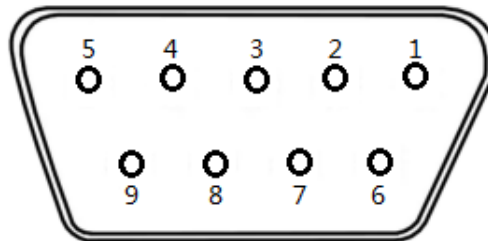

External Output Interface (Female)

Pin 1: Run/stop output. When the motor runs, it outputs a low level signal; when the motor stops, it outputs a high level signal.

Pin 3: External Output 1 (refer to chapter 4.3.4.14 to set the external control output module). This is a OC gate signal. Pull-up resistor and power supply are needed. Max power voltage is DC100V, max current is 50mA. The factory default OC gate signal is off.

Pin 4: External Output 2 (refer to chapter 4.3.4.14 to set the external control output module). This is a OC gate signal. Pull-up resistor and power supply are needed. Max power voltage is DC24V, max current is 300mA. The factory default OC gate signal is off.

Pin 5: COM for external output signal: start/stop output, running direction output, external output1, external output 2;

Pin 6: Reserved;

Pin 7: Running direction output. When the motor runs clockwise, it outputs a low level signal; when the motor runs counterclockwise, it outputs a high level signal.

Note: 5V is high level signal, and $\leq 0.8V$ is low level signal.

6 RFID Identification of Pump Head and Tubing

The Lx00-1FS series products have function of automatic identification of pump head and tubing, which can help customers easily set the pump head and tubing.

6.1 Automatic Identification of Pump Head

In the touch screen control mode, the pump head with identification label can be scanned and identified under any screen when the pump stops (except for the welcome screen). Lx00-1FS series products have a RFID identification label on the handle, as shown in the figure. When pump head attached with RFID label close to the identification area on the handle, the drive can identify the model of the pump head automatically. Note: The side with the RFID label on the pump head needs to face the identification area on the handle, and the pump head can be identified when the distance is less than 2cm.



For example: Scan a DG-2-B pump head and enter the tubing setting screen corresponding to the pump head, as shown in the figure below:

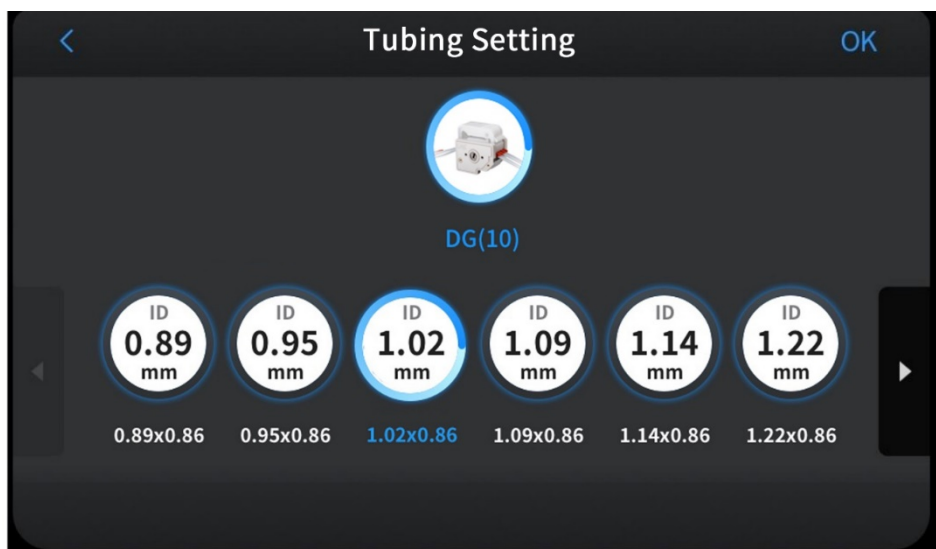

- After selecting the required tubing or scanning the tubing label, tap "OK" to save the pump head and tubing settings for current method. If there is parameter out of limit with the updated pump head and tubing settings, the pump will return to the method editing screen. If there is no parameter out of limit, the pump will return to the the screen before scanning pump head.
- Tap "<" to cancel the scan setting and return to the screen before scanning pump head.

6.2 Automatic Identification of Tubing

In the touch screen control mode, the tubing (package) with identification label can be scanned and identified under any screen when the pump stops (except for the welcome screen). Lx00-1FS series products have a RFID identification label on the handle, as shown

in the figure. When tubing package attached with RFID label close to the identification area on the handle, the drive can identify the tubing size automatically. Note: The side with the RFID label on the tubing package needs to face the identification area on the handle, and the tubing size can be identified when the distance is less than 2cm.

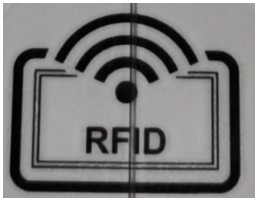

Example 1: The scanned tubing is suitable for the currently selected pump head. The pump head of the current method is YZ1515x, and a 25 # tubing is scanned, then pump enters the tubing setting screen, and the 25 # tubing is selected, as shown in the following figure:

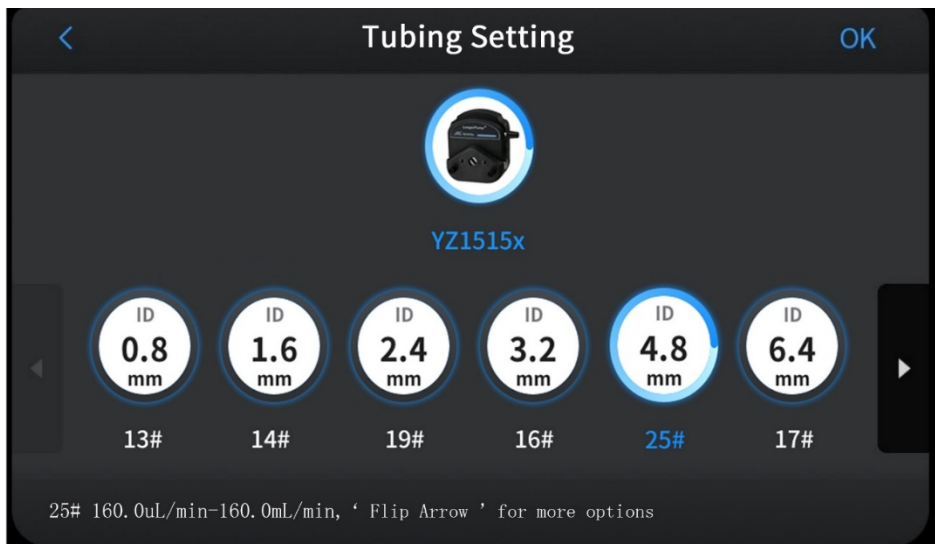

- Tap "OK" to save the tubing setting for current method. If there is parameter out of limit with the updated tubing setting, the pump will return to the method editing screen. If there is no parameter out of limit, the pump will return to the the screen before scanning tubing.
- Tap "<" to cancel the scan setting and return to the screen before scanning tubing.

Example 2: The scanned tubing is not suitable for the currently selected pump head. The pump head of the current method is BZ15-13, and a 13# tubing is scanned, then a prompt is given, as shown in the following figure:

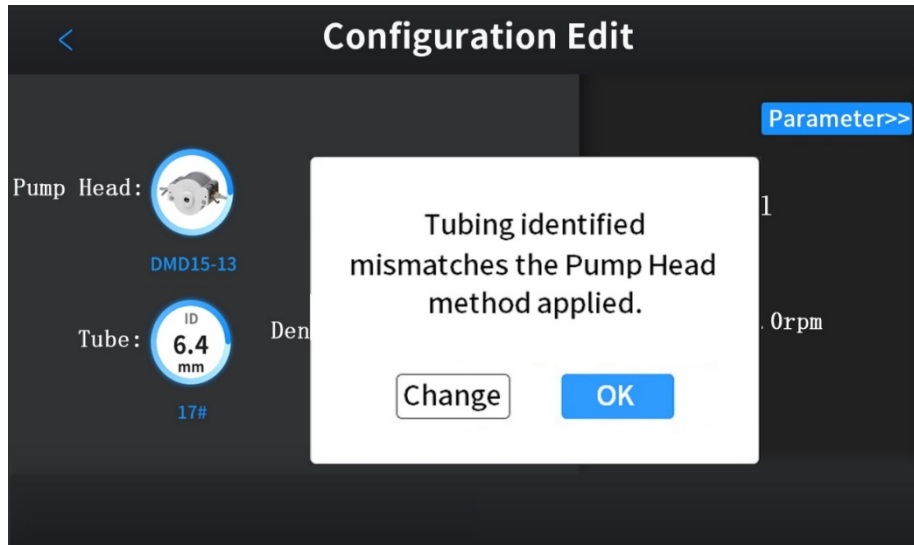

- Tap "OK" to return to the screen before scanning the tubing without making any changes.
- Tap "Change" to enter the method configuration screen to manually set the pump head and tubing.

7 Appendix

Table 1: Applicable Pump Head and Tubing, and Reference Flow Rate

Applicable pump head	Applicable silicone tubing	Applicable Pharmed tubing	Reference flow rate with silicone tubing (single channel)		
			L100-1F/ L100-1FS	L300-1F/ L300-1FS	L600-1F/ L600-1FS
YZ1515x YZ II 15	13#, 14#, 19#, 16#, 25#, 17#, 18#	13#, 14#, 19#, 16#, 25#, 17#, 18#	6.3uL/min- 366mL/min	6.3uL/min- 1100 mL/min	6.3uL/min- 2200 mL/min
FG15-13	13#, 14#, 19#, 16#, 25#, 17#, 18#	13#, 14#, 19#, 16#	6.3uL/min- 358mL/min	6.3uL/min- 1075 mL/min	6.3uL/min- 2150mL/min
DMD15-13- B	2*13#, 2*14#, 2*19#, 2*16#, 2*25#	2*13#, 2*14#, 2*19#, 2*16#	13uL/min- 345 mL/min	13uL/min- 1035 mL/min	13uL/min-2070 mL/min
DG15-24	16#, 25#, 17#	Not recommended	81uL/min- 300 mL/min	81uL/min- 900 mL/min	81uL/min-1800 mL/min
BZ15-13-A	14#	14#	25uL/min- 25 mL/min	25uL/min-75 mL/min	25uL/min-150 mL/min
BZ15-13-B	16#	16#	76uL/min- 76 mL/min	76uL/min- 230 mL/min	76uL/min-460 mL/min
BZ15-13-C	25#	25#	160uL/min- 160 mL/min	160uL/min- 480 mL/min	160uL/min-960 mL/min
BZ15-13-D	17#	Not recommended	266uL/min- 266 mL/min	266uL/min- 800 mL/min	266uL/min- 1600 mL/min
YZ2515x	15#, 24#	Not recommended	160uL/min- 266 mL/min	160uL/min- 800 mL/min	160uL/min- 1600 mL/min
YZ II 25	15#, 24#, 35#, 36#	Not recommended	160uL/min- 500 mL/min	160uL/min- 1500 mL/min	160uL/min- 3000 mL/min
FG25-13	15#, 24#	Not recommended	228uL/min- 321 mL/min	228uL/min- 965 mL/min	228uL/min- 1930 mL/min
BZ25-13-B	24#	Not recommended	266uL/min- 266 mL/min	266uL/min- 800 mL/min	266uL/min- 1600 mL/min
DG-1-A (C)	ID≤3.17mm Wall thickness: 0.8- 1mm	ID≤3.17mm Wall thickness: 0.8-1mm	0.20uL/min-48mL/min (recommended pump speed ≤100rpm)		

DG-2-A (C)	ID≤3.17mm Wall thickness: 0.8- 1mm	ID≤3.17mm Wall thickness: 0.8-1mm	
DG-4-A (C)	ID≤3.17mm Wall thickness: 0.8- 1mm	Not recommended	
DG-6-A (C)	ID≤3.17mm Wall thickness: 0.8- 1mm	Not recommended	
DG-8-A (C)	ID≤3.17mm Wall thickness: 0.8- 1mm	Not recommended	
DG-1-B (D)	ID≤3.17mm Wall thickness: 0.8- 1mm	ID ≤3.17mm Wall thickness: 0.8-1mm	0.16uL/min-39mL/min (recommended pump speed ≤100rpm)
DG-2-B (D)	ID ≤3.17mm Wall thickness: 0.8- 1mm	ID≤3.17mm Wall thickness: 0.8-1mm	
DG-4-B (D)	ID≤3.17mm Wall thickness: 0.8- 1mm	Not recommended	
DG15-28	ID≤3.17mm, wall thickness: 0.8-1mm and 13#, 14#	ID≤3.17mm Wall thickness: 0.8-1mm	0.21uL/min-77mL/min (recommended pump speed ≤100rpm)

Note: The flow rate in above table is only for the reference, which were tested at the indoor temperature (about 20°C) with water. When it comes to selecting pump heads and tubings based on flow rate, the effects of tube attenuation and liquid viscosity on flow need to be considered.

Table 2: Function & Specification

Pump model	L100-1F-A L100-1F-B	L100-1FS-A L100-1FS-B	L300-1F-A L300-1F-B	L300-1FS-A L300-1FS-B	L600-1F	L600-1FS
Automatic identification of pump head and tubing	No	Yes	No	Yes	No	Yes
Speed	0.1rpm-100rpm CW/CCW		0.1rpm-300rpm CW/CCW		0.1rpm-600rpm CW/CCW	
Speed resolution	0.1rpm		When the pump speed is less than 100rpm, the resolution is 0.1rpm; when the pump speed is more than 100rpm, the resolution is 1rpm			
Flow rate	0.16ul/min-500ml/min		0.16ul/min-1500ml/min		0.16ul/min-3000ml/min	
Power supply	L100-1F-A/L300-1F-A: AC220V±20%, 50Hz/60Hz L100-1F-B/L300-1F-B: AC110V±20%, 50Hz/60Hz				AC100V-240V, 50Hz/60Hz	
Dispensing volume	100uL-9999L (Accuracy of ±2% with calibration)					
Calibration function	Enter the measured pumping volume and automatically calibrate the flow rate and dispensing volume					
Display	7-inch high-definition color LCD with display resolution of 1024× 600;					
Display language	Chinese or English, which is settable					
Control mode	Touch screen control, foot switch control, external signal control, communication control					
Work mode	Programming					
Parameter method function	Seven parameter methods can be customized and saved, one external control method is preset, and each method parameter can be directly called.					
Programming function	Running control module (which can be used independently): Fluid transferring control: Constant speed, ramp up, ramp down, stepped up, stepped down, sine Dispensing control: constant dispensing, incremental dispensing, decremental dispensing Logic control module (steps can be triggered through external signals and					

	<p>pump status can be output to other equipment; refer to[Table 5] for details):</p> <p>Direction, delay, event trigger, external control output, pause, jump, loop, stop</p> <p>Multiple function modules can be configured in combination for multi-step and complex fluid transferring</p>
External signal control	<p>In Parameter Method 8, the start, stop, direction and pump speed are controlled by digital and analog signals; refer to[Table 3] for details.</p> <p>Start-stop control/direction control: logic level signal and switch signal are optional.</p> <p>Speed control: 0-5V/0-10V/4-20mA/0-10kHz is optional with uniform interface, and the maximum speed can be set.</p>
Communication function	<p>Modbus protocol, multiple baud rates (1200/2400/4800/9600/19200 / 38400bps), USB and RS485 (RJ11) interface for connection, refer to [Table 6] for details.</p>
Status output	<p>1. Output logic level signal to indicate the pump running status and direction status; refer to[Table 3] for details.</p> <p>2. Output switch signal at the specified step of the programmed method through the "External Control Output" module; refer to [Table 5] for details.</p>
Foot switch control	<p>Through the dedicated headset-jack interface, in Parameter Method 6 or Parameter Method 7 (only for constant fluid transferring, and only has one constant speed step, or only for constant dispensing, and only has one constant dispensing step. The direction module can be used to set the running direction), the foot switch can be used to control the start/ stop of the pump; refer to[Table 4] for details</p>
Parameter Memory	<p>Memorize the working parameters set before power off;</p>
Animation function	<p>Animated graphics show the running and direction status information of the pump;</p>
Prime function	<p>Fast filing or emptying at full speed to achieve pre-treatment and post-treatment of liquids</p>
Scheduled start function	<p>The user can set the delay start time, and the pump can start running at desired time.</p>
Fluid coefficient setting	<p>The user can set the fluid coefficient, which is convenient for adjusting and calibrating the flow rate of viscous liquid;</p>
Back suction function	<p>Antidrip through setting back suction angle and the suction delay time</p>
Dispensing volume setting range	<p>0.001uL-9999L</p>
Dispensing time	<p>0.5s-9000s</p>

and interval time setting range	
Dispensing cycle setting range	1-999999 (0 for unlimited)
Fluid transferring time setting range	1s-9000s (0s means continuous transferring without time limit)
Back suction delay time setting range	0.00s-60.00s
Program download function	The user can upgrade the firmware of the pump through a PC, which facilitates the updating of subsequent versions.
IP rating	IP31;
EMC	Key indicators reach or exceed level II; refer to [Table 7] for details.
Operating environment	Operating temperature: 0°C~40°C, relative humidity: <80%;
Outline dimensions	180mm × 291mm × 236mm (Length × width × height);
Total weight	5.0Kg;

Module Function

1	Constant speed	Transfer the fluid with constant flow rate. Parameters of flow rate, volume, time can be set. Refer to Table 8 for parameter details.
2	Ramp up	Transfer the fluid according to a linearly increasing curve. The starting flow rate, ending flow rate, running time, and other key parameters can be set. Refer to Table 8 for parameter details.
3	Ramp down	Transfer the fluid according to a linearly decreasing curve. The starting flow rate, ending flow rate, running time, and other key parameters can be set. Refer to Table 8 for parameter details.
4	Stepped up	Transfer the fluid according to evenly stepped increasing flow rate. The starting flow rate, step time, step increment, step numbers and other key parameters can be set. Refer to Table 8 for parameter details.
5	Stepped down	Transfer the fluid according to evenly stepped decreasing flow rate. The starting flow rate, step time, step decrement, step numbers and other key parameters can be set. Refer to Table 8 for parameter details.
6	Constant	Dispense the fluid with constant volume. Dispensing volume, time, cycles and

	dispensing	interval time can be set. The filling output parameter and dispensing volume could be used to calculate other parameters for customer convenience. Refer to Table 8 for parameter details.
7	Decremental dispensing	Dispense the fluid with decremental volume. Refer to Table 8 for parameter details.
8	Incremental dispensing	Dispense the fluid with incremental volume. Refer to Table 8 for parameter details.
9	Sine	Transfer the fluid according to Sine Curve. Refer to Table 8 for parameter details.
10	Direction	Set the fluid transferring direction as CW or CCW.
11	Pause	The pump can be temporarily stopped during operation by using pause module. The pause state will be terminated by receiving an external trigger signal, or manually pressing the "Continue" button that appears on the running screen, and continue to execute the next steps in the method.
12	Loop	Repeatedly execute some steps in sequence (from the start step to the end step).
13	Event Trigger	When pump receives trigger signal, the pump will immediately stop the current operation (including the loop), and instead, execute the jump step set in the event trigger module.
14	Delay	Pump can be temporarily stopped for a period of time during the running process by using delay module, which can be used at the beginning of a method for schedule start time or between modules for temporarily stop.
15	Jump	When the pump is running the jump module and receiving a jump signal, the pump will immediately stop the current operation and go to execute the set jump step in the jump module.
16	External control output	Pump will output 2 signals when pump is running the external control output module.
17	End	End module is always used at the last step in a method, to represent the termination of the method.

Table 3: External Control Functions

No.	Function	Pin	Signal type	Configuration parameter
1	Start/stop control input	D1- Pin1	1. Logic level signal Effective range of level signal: High level: 5-24V, low level \leq 0.8V 2. Relay contact signal	1. High level - start, 2. Low level - start, 3. Rising edge - change, 4. Falling edge - change.
		D1- Pin5	COM of start/stop control signal	
2	Direction control input	D1- Pin3	1. Logic level signal Effective range of level signal: High level: 5-24V, low level \leq 0.8V 2. Relay contact signal	1. High level - CW 2. Low level - CW 3. Rising edge - change, 4. Falling edge - change.
		D1- Pin5	COM of direction control signal	
3	Speed control by 0-5V signal	D1- Pin8	0-5V signal+	Maximum speed corresponding to 5V
		D1- Pin5	COM of 0-5V control signal	
4	Speed control by 0-10V	D1- Pin8	0-10V signal+	Maximum speed corresponding to 10V
		D1- Pin5	COM of 0-10V control signal	
5	Speed control by 0-10kHz	D1- Pin8	0-10kHz signal+	Maximum speed corresponding to 10KHz
		D1- Pin5	COM of pulse signal	
6	Speed control by 4-20mA	D1-Pin4	4-20mA signal +	Maximum speed corresponding to 20mA
		D1-Pin9	4-20mA signal -	
7	Run/stop status output	D2-Pin1	High level: 5V, low level \leq 0.8V	Pump runs: Low level
		D2-Pin5	COM of run/stop status output signal	Pump stops: High level
8	Direction status output	D2-Pin7	High level: 5V, low level \leq 0.8V	Motor runs CW: Low level
		D2-Pin5	COM of direction status output signal	Motor runs CCW: High level

Note: External control function is effective in Method 8 (D1 is the input interface and D2 is the output interface)

Table 4: Foot Switch Control Function

No.	Function	Signal type	Configuration parameter
1	Start-stop control input	Switch signal (relay contact signal)	Pressed to run; Unpressed to run; Pressed-unpressed to change; Disable the function;

Note 1: This function is only valid in Method 6 and Method 7;

Table 5: External Control Programming Functions

No.	Function	Pin	Signal type	Signal specifications	Configuration parameter
1	Event trigger function	D1-Pin2	Level jump signal, (Rising edge or falling edge)	5V	Triggered by rising edge;
		D1- Pin5	COM		Triggered by falling edge; Jump step
2	Jump function	D1-Pin6	Logic level signal (high level: 5V; low level: $\leq 0.8V$)	5V	High level;
		D1- Pin5	COM		Low level; Jump step
3	Pause terminating function	D1-Pin7	Level jump signal, (rising edge or falling edge)	5V	Triggered by rising edge;
		D1- Pin5	COM		Triggered by falling edge;
4	Programming status output 1	D2-Pin3	OC gate signal	Max power voltage DC 100V, max current 50mA	On, OFF
		D2-Pin5	COM		Factory default OC gate signal is off
5	Programming status output 2	D2-Pin4	OC gate signal	Max power voltage DC 24V, max current 300mA	On, OFF
		D2-Pin5	COM		Factory default OC gate signal is off

Note: D1 is the input interface and D2 is the output interface.

Table 6: Modbus RTU Protocol

Address segment type	Register address	Register name	Write	Read	Meaning
Control register segment	0x0000	Start/stop control		Last written value	0: Stop, 1: Run;
	0x0001	Fast forward control		Last written value	0: Stop, 3: Full speed forward;
	0x0002	Fast backward control		Last written value	0: Stop, 2: Full speed backward;
	0x0010	Work mode	0, 1, 2, 3	Last written value	0: speed, 1: Flow, 2: Dispense, 3: Program sequence;
	0x0011	Method number	0-MAX_Pro	Last written value	For intelligent pumps, this address is valid when "Work mode" was set as 3.
	0x0012	Control source	Setting range	Last written value	0: Internal control, 1: External control, 2: RS485, 3: Foot switch;
Configuration parameter register segment	0x0040	Pump head model		Current setting value	Refer to 5.1.4 for pump head defining range
	0x0041	Tube model		Current setting value	Refer to 5.1.5 for Tube defining range
	0x0042	Fluid coefficient		Current setting value	When work mode > 0, it is valid; when work mode = 3, it changes with "method number". Value range: 100-1000; value 100 corresponds to fluid coefficient of 1, and value 1000 corresponds to fluid coefficient of 10; For example, for fluid coefficient 1.1, the value should be 110.
	0x0043	Fluid density		Current setting value	When work mode > 0, it is valid; when work mode = 3, it changes with "method number" Value range: 100-20000; Value 100 corresponds to a density of 0.1; Value 1000 corresponds to a density of 1; For example, for fluid density 1.05, the value should be 1050.

Other system parameter segment	0x0050	Pump address	Change with original address		Value range: 1-32, it becomes valid immediately after the change
	0x0051	Baud rate	0-5		0: 1.2kbps, 1: 2.4kbps, 2: 4.8kbps, 3: 9.6kbps, 4: 19.2kbps, 5: 38.4kbps
	0x0052	Parity	0-2		0: ODD, 1: EVEN, 2: NONE
Status register (read-only area)	0x008a	Running method number		Current method number	Currently running method number
	0x008b	Current step number		Currently running step number	Currently running step number
Read-only configuration area	0x0118	Maximum method number (MAX_Pro)			Maximum method number of intelligent pump
	0x0119	Maximum method steps (MAX_Step)			Maximum method steps of intelligent pump

Address segment type	Register address	Register name	Write	Read	Meaning
Method programming area (accessible to intelligent pump)	0x0140-0x015f	Program mode - Step 1		Current step parameters	Each step contains 64 bytes; for the data arrangement structure, please refer to the <i>Programming Guide for Host computer Software of Intelligent Pump</i> .
	Last+0x0020	Program mode - Step 2		Current step parameters	The same as above
	Last+0x0020	Program mode - Step 3		Current step parameters	The same as above
	Last+0x0020	Program mode - Step 4		Current step parameters	The same as above
	Last+0x0020	Program mode - Step 5		Current step parameters	The same as above

	Last+0x00 20	Program mode - Step 6		Current step parameters	The same as above
	Last+0x00 20	Program mode - Step 7		Current step parameters	The same as above
	Last+0x00 20	Program mode - Step 8		Current step parameters	The same as above
	Last+0x00 20	Program mode - Step 9		Current step parameters	The same as above
	Last+0x00 20	Program mode - Step 10		Current step parameters	The same as above

Table 6.1: Pump Head Definition in Modbus RTU Protocol

Corresponding value of pump head					
No.	Pump head model	Value	No.	Pump head	Value
1	Undefined	0	11	DG15_24	10
2	DMD15_13	1	12	DG15_28	11
3	YZ1515X	2	14	DG_6	13
4	YZII15	3	15	DG_10	14
5	YZ2515X	4			
6	YZII25	5			
7	FG15_13	6			
8	FG25_13	7			
9	BZ15_13	8			
10	BZ25_13	9			

Table 6.2: Tubing Definition in Modbus RTU Protocol

Corresponding value of tubing					
No.	Tube	Value	No.	Tube	Value
1	#13	0	26	0.76x0.86mm	25
2	#14	1	27	0.89x0.86mm	26
3	#19	2	28	0.95x0.86mm	27
4	#16	3	29	1.02x0.86mm	28
5	#25	4	30	1.09x0.86mm	29

6	#17	5	31	1.14x0.86mm	30
7	#18	6	32	1.22x0.86mm	31
8	#119	7	33	1.30x0.86mm	32
9	#120	8	34	1.42x0.86mm	33
10	#15	9	35	1.52x0.86mm	34
11	#24	10	36	1.65x0.86mm	35
12	#35	11	37	1.75x0.86mm	36
13	#36	12	38	1.85x0.86mm	37
14	0.5x0.8mm	13	39	2.06x0.86mm	38
15	1x1mm	14	40	2.29x0.86mm	39
16	2x1mm	15	41	2.54x0.86mm	40
17	3x1mm	16	42	2.79x0.86mm	41
18	0.13x0.91mm	17			
19	0.91x0.91mm	18			
20	0.25x0.91mm	19			
21	0.38x0.91mm	20			
22	0.44x0.91mm	21			
23	0.51x0.91mm	22			
24	0.57x0.91mm	23			
25	0.64x0.91mm	24			

Table 7: EMC items**Emission Part**

Item	Standard	Method	Requirement	Result
Conducted Emissions at Mains Terminals (150kHz-30MHz)	EN 61326-1:2013	EN 55011:2016+A1:2017	Group 1 Class A	Pass
Radiated Emissions (30MHz-1GHz)	EN 61326-1:2013	EN 55011:2016+A1:2017	Group 1 Class A	Pass
Harmonic Current Emission	EN 61326-1:2013	EN 61000-3-2:2014	Class A	Pass
Voltage Fluctuations and Flicker	EN 61326-1:2013	EN 61000-3-3:2013	Clause 5 of EN 61000-3-3	Pass

Immunity Part

Item	Standard	Method	Requirement	Result
Electrostatic Discharge	EN 61326-1:2013	EN 61000-4-2:2009	4kV Contact Discharge 8kV Air Discharge	Pass
Radiated Immunity(80MHz-2.7GHz)	EN 61326-1:2013	EN 61000-4-3:2006 +A1:2008+A2:2010	3V/m, 80%, 1kHz Amp. Mod. 3V/m, 80%, 1kHz Amp. Mod. 1V/m, 80%, 1kHz Amp. Mod.	Pass
Electrical Fast Transients/Burst at Power Port	EN 61326-1:2013	EN 61000-4-4:2012	1kV 5/50ns Tr/Td 5kHz Repetition Frequency	Pass
Surge at Power Port	EN 61326-1:2013	EN 61000-4-5:2014 +A1:2017	1.2/50µs Tr/Td 0.5kV Line to Line 1kV Line to Ground	Pass
Conducted Immunity at Power Port (150kHz-80MHz)	EN 61326-1:2013	EN 61000-4-6:2014	3Vrms (emf),80%,1kHz Amp. Mod.	Pass
Voltage Dips and Interruptions	EN 61326-1:2013	EN 61000-4-11:2004 +A1:2017	0 % UT for 0.5per 0 % UT for 1per 70 % UT for 25per 0 % UT for 250per UT is Supply Voltage	Pass

Table 8: Parameter List of Programming Modules

Table 8 (1): Parameter list of Constant Speed Module

Constant speed module						
No.	Setting parameter	Type	Parameter range	Resolution	Unit	Remarks
1	Flow rate	Setting value	0.001-9999	0.001	uL/min, mL/min	Minimum flow ≤ Flow rate ≤ Maximum flow
2	Volume	Setting value	0.001-9999	0.001	uL, mL	Minimum volume = Minimum flow rate * 0.5sec Maximum volume = Maximum flow rate * 9000sec
3	Time	Setting value	0,1-9000	0.001	sec	0 means unlimited, 1sec-9000sec
			0.1-150	0.001	min	0.1min-150min
4	Back suction angle	Setting value	0-999	1	Degree	

Table 8 (2): Parameter List of Ramp Up Module

Constant acceleration running module						
No.	Setting parameter	Type	Parameter range	Resolution	Unit	Remarks
1	Starting flow rate	Setting value	0.001-9999	0.001	uL/min, mL/min	Minimum flow \leq Starting flow rate \leq Maximum flow
2	Ending flow rate	Setting value	0.001-9999	0.001	uL/min, mL/min	Initial flow \leq Ending flow rate \leq Maximum flow
3	Time	Setting value	0,1-9000	0.001	sec	0 means unlimited, 1sec-9000sec
			0.1-150	0.001	min	0.1min-150min

Table 8 (3): Parameter list of Ramp Down Module

Constant deceleration running module						
No.	Setting parameter	Type	Parameter range	Resolution	Unit	Remarks
1	Starting flow rate	Setting value	0.001-9999	0.001	uL/min, mL/min	Minimum flow \leq Starting flow rate \leq Maximum flow
2	Ending flow rate	Setting value	0.001-9999	0.001	uL/min, mL/min	Minimum flow \leq Ending flow rate \leq Initial flow
3	Time	Setting value	0,1-9000	0.001	sec	0 means unlimited, 1sec-9000sec
			0.1-150	0.001	min	0.1min-150min

Table 8 (4): Parameter list of stepped up module

Step acceleration running module						
No.	Setting parameter	Type	Parameter range	Resolution	Unit	Remarks
1	Starting flow rate	Setting value	0.001-9999	0.001	uL/min, mL/min	Minimum flow \leq Starting flow rate \leq Maximum flow
2	Step increment	Setting value	0.001-9999	0.001	uL/min, mL/min	
3	Number of steps	Setting value	1-99	1	None	1 is equivalent to no step
4	Step time	Setting value	0,1-9000	0.001	sec	0 means infinite, 1sec-9000sec
			0.1-150	0.001	min	0.1min-150min

Table 8 (5): Parameter list of stepped down module

Step deceleration running module						
No.	Setting parameter	Type	Parameter range	Resolution	Unit	Remarks
1	Starting flow rate	Setting value	0.001-9999	0.001	uL/min, mL/min	Minimum flow \leq Starting flow rate \leq Maximum flow
2	Step decrement	Setting value	0.001-9999	0.001	uL/min, mL/min	
3	Number of steps	Setting value	1-99	1	None	1 is equivalent to no step
4	Step time	Setting value	0,1-9000	0.001	sec	0 means unlimited, 1sec-9000sec
			0.1-150	0.001	min	0.1min-150min

Note: The abovementioned five modules are provided with the displayed values of the maximum flow rate and the minimum flow rate; the maximum flow rate is obtained from the flow curve of the set pump head & tube @max pump speed. The minimum flow is obtained from the flow curve of the set pump head & tube @0.1rpm.

Table 8 (6): Parameter list of constant dispensing module

Uniform dispensing running module						
No.	Setting parameter	Type	Parameter range	Resolution	Unit	Remarks
1	Dispensing volume	Setting value	0.001-9999	0.001	uL/min, mL/min	Minimum volume = Minimum flow rate * 0.5sec Maximum volume = Maximum flow rate * 9000sec
2	Dispensing time; Interval time	Setting value	0.5-9000	0.001	sec	0.5sec-9000sec
			0.1-150	0.001	min	0.1min-150min
3	Dispensing times	Setting value	0, 1-999999	1	None	0 means unlimited
4	Filling Output	Setting value	1-3600	1	sec	Depending on the dispensing time and interval time
5	Back suction delay time	Setting value	0-60	0.01	sec	Back suction speed is the max speed of the pump.
6	Back suction angle	Setting value	0-999	1	Degree	

Note: After adjustments to the output value are made, the dispensing time is adjusted accordingly.

Table 8 (7): Parameter list of incremental dispensing module

Incremental dispensing module						
No.	Setting parameter	Type	Parameter range	Resolution	Unit	Remarks
1	Starting Dispensing volume	Setting value	0.001-9999	0.001	uL, mL	
2	Dispensing time; Interval time	Setting value	0.5-9000	0.001	sec	0.5sec-9000sec
			0.1-150	0.001	min	0.1min-150min
3	Step increment	Setting value	0.001-9999	0.001	uL, mL	
4	Number of steps	Setting value	1-99	1	None	
5	Dispensing times	Setting value	1-999999	1	None	
6	Back suction delay time	Setting value	0-60	0.01	sec	Back suction speed is the max speed of the pump.
7	Back suction angle	Setting value	0-999	1	Degree	

Table 8 (8): Parameter list of decremental dispensing module

Decremental dispensing module						
No.	Setting parameter	Type	Parameter range	Resolution	Unit	Remarks
1	Starting Dispensing volume	Setting value	0.0001-9999	0.001	uL, mL	
2	Dispensing time; Interval time	Setting value	0.5-9000	0.001	sec	0.5sec-9000sec
			0.1-150	0.001	min	0.1min-150min
3	Step decrement	Setting value	0.001-9999	0.001	uL, mL	
4	Number of steps	Setting value	1-99	1	None	
5	Dispensing times	Setting value	1-999999	1	None	
6	Back suction delay time	Setting value	0-60	0.01	sec	Back suction speed is the max speed of the pump.
7	Back suction angle	Setting value	0-999	1	Degree	

Table 8 (9): Parameter List of Sine Module

Sine Module						
No.	Setting parameter	Type	Parameter range	Resolution	Unit	Remarks
1	Offset	Setting value	0.001-9999	0.001	uL/min, mL/min	Amplitude <offset
2	Amplitude	Setting value	0.001-9999	0.001	uL/min, mL/min	Amplitude <offset
3	Period	Setting value	5-9000	0.001	sec	
4	Time	Setting value	1-9000	0.001	sec	1sec-9000sec
			0.1-150	0.001	min	0.1min-150min

Table 8 (10): Parameter List of Control Module

Control module					
No.	Control module	Setting parameter	Type	Parameter range	Remarks
1	Direction module	Running direction	Setting value	Clockwise, counterclockwise	Single choice
2	Pause module	Signal type	Setting value	Rising edge or falling edge	Single choice The "Continue" button is always effective.
3	Loop module	Number of loops	Setting value	∞ or 1-1000	∞ means infinite loop
		Start step	Setting value	1-7	
		End step	Setting value	2-8	Greater than the start step value
4	Event trigger module	Trigger method	Setting value	Rising edge or falling edge	Single choice
		Jump	Setting value	2-10	
5	Delay module	Delay	Setting value	0.5sec-9000sec	The unit is set as sec
				0.1min-150min	The unit is set as min
6	Jump module	Input signal	Setting value	Low level, high level	Single choice
		Jump step	Setting value	2-10	
7	External control output module	Output 1	Setting value	On, Off	Single choice
		Output 2	Setting value	On, Off	Single choice
8	End module	None			

Table 9 Modbus RTU Protocol Data Structure Table for Steps

Method programming area starts from address of 0X0140. Each step contains 32 words, offset by 0X0020. The method has a maximum of 10steps, which must be ended with End Module.

Table 9 (1) Constant Speed Module

Constant Speed			
Parameter	Words Count	Offset address	Note
Module ID(11)	1	0X00	Module ID: 11, indicates current step is constant speed module.
Null	1	0X01	Reserved
Running time	2	0X02	Low address: low order word of the data, high address: high order word of the data Data format: contains 4 integers and 4 decimals. Example: send the data of 12345, means 1.2345. send the data of 12345000, means 1234.5 Data range: 10000-90000000
Back suction angle	1	0X04	Data range: 0-999 (unit: degree)
Unit of running time	1	0X05	Sec: 0; min: 1
Null	2	0X06	Reserved
Null	1	0X08	Reserved
Null	1	0X09	Reserved
Null	2	0X0A	Reserved
Flow rate	2	0X0C	Low address: low order word of the data, high address: high order word of the data Data format: contains 4 integers and 4 decimals. Example: send the data of 12345, means 1.2345; send the data of 12345000, means 1234.5 Data range: refer to flow rate curve of corresponding pump head and tubing. Example: max flow rate of the pump head and tubing is 460mL/min. When set the flow rate unit as mL/min, the max data of flow rate sent to pump is 4600000.
Unit of flow rate	1	0X0E	ul/min: 0; ml/min: 1
Null	1	0X0F	Reserved
Null	2	0X10	Reserved
Null	1	0X12	Reserved

Table 9 (2) Ramp Up Module

Ramp Up			
Parameter	Words Count	Offset address	Note
Module ID(17)	1	0X00	Module ID: 17, indicates current step is ramp up module
Null	1	0X01	Reserved
Starting flow rate	2	0X02	Low address: low order word of the data, high address: high order word of the data Data format: contains 4 integers and 4 decimals. Example: send the data of 12345, means 1.2345; send the data of 12345000, means 1234.5 Data range: refer to flow rate curve of corresponding pump head and tubing. Example: max flow rate of the pump head and tubing is 460mL/min. When set the flow rate unit as mL/min, the max data of flow rate sent to pump is 4600000.
Unit of starting flow rate	1	0X04	ul/min: 0; ml/min: 1
Null	1	0X05	Reserved
Ending flow rate	2	0X06	Low address: low order word of the data, high address: high order word of the data Data format: contains 4 integers and 4 decimals. Example: send the data of 12345, means 1.2345; send the data of 12345000, means 1234.5 Data range: refer to flow rate curve of corresponding pump head and tubing. Example: max flow rate of the pump head and tubing is 460mL/min. When set the flow rate unit as mL/min, the max data of flow rate sent to pump is 4600000.
Unit of ending flow rate	1	0X08	ul/min: 0; ml/min: 1
Null	1	0X09	Reserved
Running time	2	0X0A	Low address: low order word of the data, high address: high order word of the data Data format: contains 4 integers and 4 decimals. Example: send the data of 12345, means 1.2345. send the data of 12345000, means 1234.5 Data range: 10000-90000000
Unit of running time	1	0X0C	sec: 0; min: 1
Null	1	0X0D	Reserved

Table 9 (3) Ramp Down Module

Ramp Down			
Parameter	Words Count	Offset address	Note
Module ID(18)	1	0X00	Module ID: 18, indicates current step is ramp down module
Null	1	0X01	Reserved
Starting flow rate	2	0X02	Low address: low order word of the data, high address: high order word of the data Data format: contains 4 integers and 4 decimals. Example: send the data of 12345, means 1.2345; send the data of 12345000, means 1234.5 Data range: refer to flow rate curve of corresponding pump head and tubing. Example: max flow rate of the pump head and tubing is 460mL/min. When set the flow rate unit as mL/min, the max data of flow rate sent to pump is 4600000.
Unit of starting flow rate	1	0X04	ul/min: 0; ml/min: 1
Null	1	0X05	Reserved
Ending flow rate	2	0X06	Low address: low order word of the data, high address: high order word of the data Data format: contains 4 integers and 4 decimals. Example: send the data of 12345, means 1.2345; send the data of 12345000, means 1234.5 Data range: refer to flow rate curve of corresponding pump head and tubing. Example: max flow rate of the pump head and tubing is 460mL/min. When set the flow rate unit as mL/min, the max data of flow rate sent to pump is 4600000.
Unit of ending flow rate	1	0X08	ul/min: 0; ml/min: 1
Null	1	0X09	Reserved
Running time	2	0X0A	Low address: low order word of the data, high address: high order word of the data Data format: contains 4 integers and 4 decimals. Example: send the data of 12345, means 1.2345. send the data of 12345000, means 1234.5 Data range: 10000-90000000
Unit of running time	1	0X0C	sec: 0; min: 1
Null	1	0X0D	Reserved

Table 9 (4) Stepped Up Module

Stepped Up			
Parameter	Words Count	Offset address	Note
Module ID(21)	1	0X00	Module ID: 21, indicates current step is stepped up module
Null	1	0X01	Reserved
Step Running time	2	0X02	Low address: low order word of the data, high address: high order word of the data Data format: contains 4 integers and 4 decimals. Example: send the data of 12345, means 1.2345. send the data of 12345000, means 1234.5 Data range: 10000-90000000
Null	1	0X04	Reserved
Unit of running time	1	0X05	sec: 0; min: 1
Step increment of flow rate	2	0X06	Low address: low order word of the data, high address: high order word of the data Data format: contains 4 integers and 4 decimals. Example: send the data of 12345, means 1.2345; send the data of 12345000, means 1234.5 Data range: refer to flow rate curve of corresponding pump head and tubing. Example: max flow rate of the pump head and tubing is 460mL/min. When set the flow rate unit as mL/min, the max data of flow rate sent to pump is 4600000.
Unit of flow rate increment	1	0X08	ul/min: 0; ml/min: 1
Null	1	0X09	Reserved
Number of steps	2	0X0A	Low address: low order word of the data, high address: high order word of the data Data range: 1-99
Starting flow rate	2	0X0C	Low address: low order word of the data, high address: high order word of the data Data format: contains 4 integers and 4 decimals. Example: send the data of 12345, means 1.2345; send the data of 12345000, means 1234.5 Data range: refer to flow rate curve of corresponding pump head and tubing. Example: max flow rate of the pump head and tubing is 460mL/min. When set the flow rate unit as mL/min, the max data of flow rate sent to pump is 4600000
Unit of flow rate	1	0X0E	ul/min: 0; ml/min: 1
Null	1	0X0F	Reserved
Null	2	0X10	Reserved
Null	1	0X12	Reserved

Table 9 (5) Stepped Down Module

Stepped Down			
Parameter	Words Count	Offset address	Note
Module ID(22)	1	0X00	Module ID: 22, indicates current step is stepped down module
Null	1	0X01	Reserved
Step Running time	2	0X02	Low address: low order word of the data, high address: high order word of the data Data format: contains 4 integers and 4 decimals. Example: send the data of 12345, means 1.2345. send the data of 12345000, means 1234.5 Data range: 10000-90000000
Null	1	0X04	Reserved
Unit of Running time	1	0X05	sec: 0; min: 1
Step decrement of flow rate	2	0X06	Low address: low order word of the data, high address: high order word of the data Data format: contains 4 integers and 4 decimals. Example: send the data of 12345, means 1.2345; send the data of 12345000, means 1234.5 Data range: refer to flow rate curve of corresponding pump head and tubing. Example: max flow rate of the pump head and tubing is 460mL/min. When set the flow rate unit as mL/min, the max data of flow rate sent to pump is 4600000.
Unit of flow rate decrement	1	0X08	ul/min: 0; ml/min: 1
Null	1	0X09	Reserved
Number of steps	2	0X0A	Low address: low order word of the data, high address: high order word of the data Data range: 1-99
Starting flow rate	2	0X0C	Low address: low order word of the data, high address: high order word of the data Data format: contains 4 integers and 4 decimals. Example: send the data of 12345, means 1.2345; send the data of 12345000, means 1234.5 Data range: refer to flow rate curve of corresponding pump head and tubing. Example: max flow rate of the pump head and tubing is 460mL/min. When set the flow rate unit as mL/min, the max data of flow rate sent to pump is 4600000.
Unit of flow rate	1	0X0E	ul/min: 0; ml/min: 1
Null	1	0X0F	Reserved
Null	2	0X10	Reserved
Null	1	0X12	Reserved

Table 9 (6) Sine Curve Module

Sine			
Parameter	Words Count	Offset address	Note
Model ID(7)	1	0X00	Model ID: 7 indicates current step is sine curve module
Null	1	0X01	Reserved
Amplitude	2	0X02	<p>Amplitude is the distance from the peak of the sine wave to the midpoint.</p> <p>Low address: low order word of the data, high address: high order word of the data</p> <p>Data format: contains 4 integers and 4 decimals. Example: send the data of 12345, means 1.2345; send the data of 12345000, means 1234.5</p> <p>Data range: refer to flow rate curve of corresponding pump head and tubing. Example: max flow rate of the pump head and tubing is 460mL/min. When set the flow rate unit as mL/min, the max data of flow rate sent to pump is 4600000.</p>
Offset	2	0X04	<p>Offset is the distance by which the sine wave's midpoint is offset from the 0 point.</p> <p>Minimum flow rate \leq offset - amplitude</p> <p>Offset + amplitude \leq maximum flow rate</p> <p>Low address: low order word of the data, high address: high order word of the data</p> <p>Data format: contains 4 integers and 4 decimals. Example: send the data of 12345, means 1.2345; send the data of 12345000, means 1234.5</p> <p>Data range: refer to flow rate curve of corresponding pump head and tubing. Example: max flow rate of the pump head and tubing is 460mL/min. When set the flow rate unit as mL/min, the max data of flow rate sent to pump is 4600000.</p>
Unit of amplitude	1	0X06	ul/min: 0; ml/min: 1
Unit of offset	1	0X07	ul/min: 0; ml/min: 1
Cycle time	2	0X08	<p>Low address: low order word of the data, high address: high order word of the data</p> <p>Data format: contains 4 integers and 4 decimals. Example: send the data of 12345, means 1.2345. send the data of 12345000, means 1234.5</p> <p>Data range: 50000-90000000</p>
Running time	2	0X0A	<p>Low address: low order word of the data, high address: high order word of the data</p> <p>Data format: contains 4 integers and 4 decimals. Example: send the data of 12345, means 1.2345. send the data of 12345000, means 1234.5</p> <p>Data range: 10000-90000000</p>
Unit of cycle time	1	0X0C	sec: 0; min: 1
Unit of running time	1	0X0D	sec: 0; min: 1

Table 9 (7) Constant Dispensing Module

Constant Dispensing			
Parameter	Words Count	Offset address	Note
Module ID(12)	1	0X00	Module ID: 12, indicates current step is Constant Dispensing module
Null	1	0X01	Reserved
Null	2	0X02	Reserved
Null	1	0X04	Reserved
Null	1	0X05	Reserved
Null	2	0X06	Reserved
Dispensing volume	2	0X08	Low address: low order word of the data, high address: high order word of the data Data format: contains 4 integers and 4 decimals. Example: send the data of 12345, means 1.2345; send the data of 12345000, means 1234.5 Data range: 10-99990000
Unit of dispensing volume	1	0X0A	ul: 0; ml: 1; L: 2
Null	1	0X0B	Reserved
Dispensing time	2	0X0C	Low address: low order word of the data, high address: high order word of the data Data format: contains 4 integers and 4 decimals. Example: send the data of 12345, means 1.2345; send the data of 12345000, means 1234.5 Data range: 5000-90000000
Unit of Dispensing time	1	0X0E	sec: 0; min: 1
Null	1	0X0F	Reserved
Interval time	2	0X10	Low address: low order word of the data, high address: high order word of the data Data format: contains 4 integers and 4 decimals. Example: send the data of 12345, means 1.2345; send the data of 12345000, means 1234.5 Data range: 5000-90000000
Unit of interval time	1	0X12	sec: 0; min: 1
Null	1	0X13	Reserved
Back suction delay	2	0X14	Low address: low order word of the data, high address: high order word of the data Data format: contains 2 integers and 2 decimals. Example: send the data of 1234, means 12.34 Data range: 0-6000
Back suction angle	1	0X16	Data range: 0-999, unit: degree
Null	1	0X17	Reserved
Dispensing cycles	2	0X18	Low address: low order word of the data, high address: high order word of the data Data range: 0-999999, '0' means ∞

Table 9 (8) Incremental Dispensing Module

Incremental Dispensing			
Parameter	Words Count	Offset Address	Note
Module ID(19)	1	0X00	Module ID: 19, indicates current step is incremental dispensing module
Null	1	0X01	Reserved
Step increment of liquid volume	2	0X02	Low address: low order word of the data, high address: high order word of the data Data format: contains 4 integers and 4 decimals. Example: send the data of 12345, means 1.2345; send the data of 12345000, means 1234.5 Data range: 10-99990000
Unit of liquid volume increment	1	0X04	ul: 0; ml: 1; L: 2
Null	1	0X05	Reserved
Number of steps	2	0X06	Low address: low order word of the data, high address: high order word of the data Data range: 1-99
Starting dispensing volume	2	0X08	Low address: low order word of the data, high address: high order word of the data Data format: contains 4 integers and 4 decimals. Example: send the data of 12345, means 1.2345; send the data of 12345000, means 1234.5 Data range: 10-99990000
Unit of starting dispensing volume	1	0X0A	ul: 0; ml: 1; L: 2
Null	1	0X0B	Reserved
Dispensing time	2	0X0C	Low address: low order word of the data, high address: high order word of the data Data format: contains 4 integers and 4 decimals. Example: send the data of 12345, means 1.2345; send the data of 12345000, means 1234.5 Data range: 5000-90000000
Unit of dispensing time	1	0X0E	sec: 0; min: 1
Null	1	0X0F	Reserved
Interval time	2	0X10	Low address: low order word of the data, high address: high order word of the data Data format: contains 4 integers and 4 decimals. Example: send the data of 12345, means 1.2345; send the data of 12345000, means 1234.5 Data range: 5000-90000000
Unit of interval time	1	0X12	sec: 0; min: 1
Null	1	0X13	Reserved
Back suction delay	2	0X14	Low address: low order word of the data, high address: high order word of the data Data format: contains 2 integers and 2 decimals. Example: send the data of 1234, means 12.34 Data range: 0-6000
Back suction angle	1	0X16	Data range: 0-999, unit: degree
Null	1	0X17	Reserved
Dispensing cycles	2	0X18	Low address: low order word of the data, high address: high order word of the data Data range:1-999999

Table 9 (9) Decremental Dispensing Module

Decremental Dispensing			
Parameter	Words Count	Offset Address	Note
Module ID(20)	1	0X00	Module ID: 20, indicates current step is decremental dispensing module
Null	1	0X01	Reserved
Step decrement of liquid volume	2	0X02	Low address: low order word of the data, high address: high order word of the data Data format: contains 4 integers and 4 decimals. Example: send the data of 12345, means 1.2345; send the data of 12345000, means 1234.5 Data range: 10-99990000
Unit of liquid volume decrement	1	0X04	ul: 0; ml: 1; L: 2
Null	1	0X05	Reserved
Number of steps	2	0X06	Low address: low order word of the data, high address: high order word of the data Data range: 1-99
Starting dispensing volume	2	0X08	Low address: low order word of the data, high address: high order word of the data Data format: contains 4 integers and 4 decimals. Example: send the data of 12345, means 1.2345; send the data of 12345000, means 1234.5 Data range: 10-99990000
Unit of starting dispensing volume	1	0X0A	ul: 0; ml: 1; L: 2
Null	1	0X0B	Reserved
Dispensing time	2	0X0C	Low address: low order word of the data, high address: high order word of the data Data format: contains 4 integers and 4 decimals. Example: send the data of 12345, means 1.2345; send the data of 12345000, means 1234.5 Data range: 5000-90000000
Unit of dispensing time	1	0X0E	sec: 0; min: 1
Null	1	0X0F	Reserved
Interval time	2	0X10	Low address: low order word of the data, high address: high order word of the data Data format: contains 4 integers and 4 decimals. Example: send the data of 12345, means 1.2345; send the data of 12345000, means 1234.5 Data range: 5000-90000000
Unit of interval time	1	0X12	sec: 0; min: 1
Null	1	0X13	Reserved
Back suction delay	2	0X14	Low address: low order word of the data, high address: high order word of the data Data format: contains 2 integers and 2 decimals. Example: send the data of 1234, means 12.34 Data range: 0-6000
Back suction angle	1	0X16	Data range: 0-999
Null	1	0X17	Reserved
Dispensing cycles	2	0X18	Low address: low order word of the data, high address: high order word of the data Data range: 1-999999

Table 9 (10) Direction Module

Direction			
Parameter	Words Count	Offset Address	Note
Module ID(8)	1	0X00	Module ID: 8, indicates current step is direction module
Direction	1	0X01	CW: 1, CCW: 0

Table 9 (11) Pause Module

Pause			
Parameter	Words Count	Offset Address	Note
Module ID(10)	1	0X00	Module ID: 10, indicates current step is pause module
Null	1	0X01	Reserved
The type of external signal for terminating the pause state	1	0X02	Falling edge : 0 ; Rising edge : 1
Null	1	0X03	Reserved

Table 9 (12) Loop Module

Loop			
Parameter	Words Count	Offset Address	Note
Module ID(4)	1	0X00	Module ID: 4, indicates current step is loop module
Start step	1	0X01	Data range: 1 to (the number of total steps of the method-3) (max number of total steps is10)
End step	1	0X02	Data range: 2 to (the number of total steps of the method-2) (max number of total steps is10)
Null	1	0X03	Reserved
Number of cycles	2	0X04	Low address: low order word of the data, high address: high order word of the data Data range: 0-1000, '0'means ∞

Table 9 (13) Event Trigger Module

Event Trigger			
Parameter	Words Count	Offset Address	Note
Module ID(15)	1	0X00	Module ID: 15, indicates current step is event trigger module
Null	1	0X01	Reserved
The type of trigger signal	1	0X02	Falling edge: 0; Rising edge: 1
The step jump to	1	0X03	Data range: (Step number+1) to the number of total steps (max number of total steps is10)

Table 9 (14) Delay Module

Delay			
Parameter	Words Count	Offset Address	Note
Module ID(13)	1	0X00	Module ID: 13, indicates current step is delay module
Null	1	0X01	Reserved
Delay time	2	0X02	Low address: low order word of the data, high address: high order word of the data Data format: contains 4 integers and 4 decimals. Example: send the data of 12345, means 1.2345; send the data of 12345000, means 1234.5 Data range: 5000-90000000
Unit of delay time	1	0X04	sec: 0; min: 1
Null	1	0X05	Reserved

Table 9 (15) Jump Module

Jump			
Parameter	Words Count	Offset Address	Note
Module ID(3)	1	0X00	Module ID: 3, indicates current step is jump module
The step jump to	1	0X01	Data range: (Step number+1) to the number of total steps (max number of total steps is10)
The type of trigger signal	1	0X02	Low level signal: 0; High level signal: 1

Table 9 (16) External Output Module

External Output			
Parameter	Words Count	Offset Address	Note
Module ID(16)	1	0X00	Module ID: 16, indicates current step is external output module
Null	1	0X01	Reserved
Output	1	0X02	bit0: output 1; bit1: output 2; OC gate signal is off:0; on: 1
Null	1	0X03	Reserved

Table 9 (17) Stop Module

Stop			
Parameter	Words Count	Offset Address	Note
Module ID(5)	1	0X00	Module ID: 5, indicates current step is stop module
Null	1	0X01	Reserved