

 **IMPORTANT INFORMATION:**

Please read operation manual carefully before operation.

 **WARNINGS:**

- Tubing breakage may result in fluid sprayed from pump. Use appropriate measures to protect operator and equipment. Please check the tubing frequently and change the tubing in time.

- If the power line or the plug is worn or damaged please pull out the plug (Hold the plug not the power line when pulling out).

- Please shut down the power supply and pull out the plug when meet below circumstance :
The fluids splash on the body of the pump.
You think the pump needs to be maintained or repaired.

- Please shut down the power supply before install the external control equipments.

Table of Contents

Instruction	1
Operation Panel	2
Basic Operation	2
Running Interface	3
Flow Rates Display	3
Dispensing Display	3
Acceptable Pump Head and Tubing	4
Changing the Pump Head	5
Menu Diagram	5
System Setting	6
Pump Head and Tubing Setting	6
External Control Setting	6
Pump address Setting	6
Footswitch Setting	7
Back Suction rpm Setting	7
Control Mode	8
Dispensing Setting	8
Dispensing Volume	8
Copy No.	8
Flow Rates	9
Pause Time	9
Calibration	9
Flow Rates Calibration	9
Dispensing Volume Calibration	10
Operation Procedure	11
Flow Rates Mode	11
Dispensing Mode	11
External Control Input	12
External Control Output	14
Footswitch Function	14
Communication Function	15
Maintenance	15
Warranty	15
Technical Specification	16

Introduction

Acceptable pump heads for WT600-1F are YZ1515x, YZ2515x, YZ1115, YZ1125, DG15-24, KZ25, BZ25 and DMD25. The pump delivers flow rates from 0.7 to 6000 mL/min and dispensing volume is from 0.1 mL to 9900 mL. Combining 128 × 32 LCD display with membrane keypad and rotary coded switch makes the operation easy and prompt. The speed can be adjusted manually or automatically through external control interface.

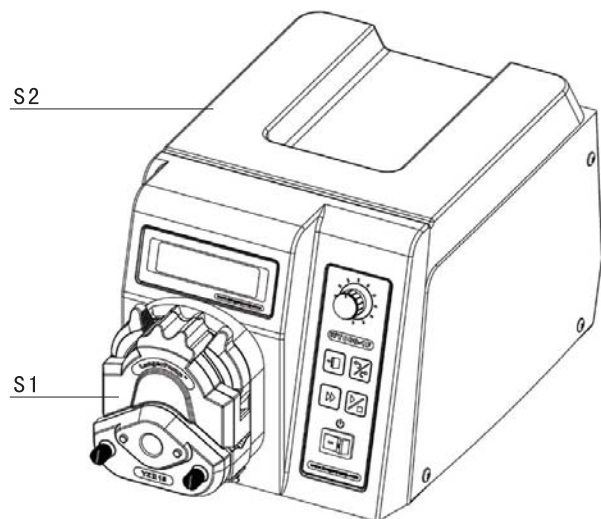

- S Standard Configuration
- S1 Pump Head
- S2 Drive
- P Part
- P1 External Control Output Port
- P2 External Control Input Port
- P3 Power Socket
- P4 Infuse Holder

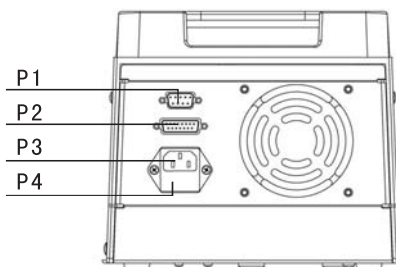

Note:

- Please see page 12 for detailed external control function.
- Make sure the power line of the pump is grounded reliably to protect the operator in humid condition.

Operation Panel

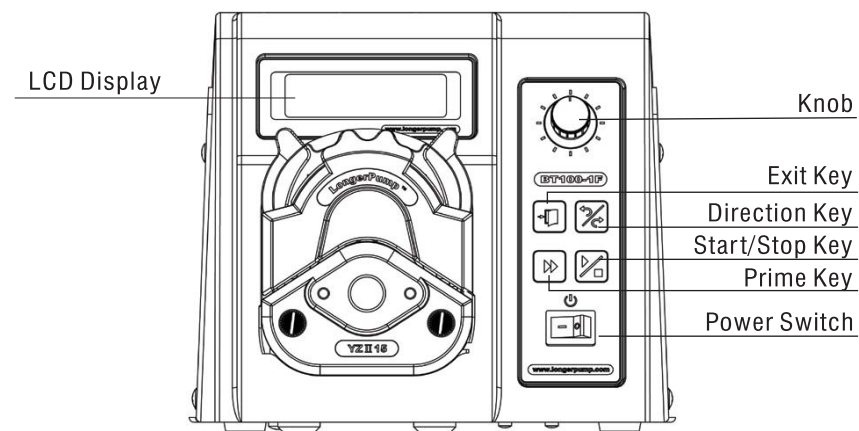

Basic Operation

- **Start/Stop Key**
Press the **Start/Stop Key** to start or stop the pump.
- **Direction Key**
Press the **Direction Key** to change the rotation direction of the pump.
- **Knob**
Function 1: Turn the **Knob** to adjust the flow rates in flow rates display state.
Function 2: Turn the **Knob** to select the menu and set the parameters, press **Knob** for confirmation in menus selection state.
- **Prime Key**
In common state, press the **Prime Key** to enter prime state when the pump runs at full speed for emptying, filling and rinsing operation; Press the **Prime Key** again to return to common state. In prime state, other keys are invalid.
- **Exit Key**
Function 1: Cancel current operation and return to previous menu.
Function 2: In dispensing mode, press **Exit Key** to switch different dispensing parameters display.
- **Power Switch**
Turn on or off the pump.

Running Interface

Turn on the pump, the pump is initialized first, then display the running interface.

- Flow Rate Display

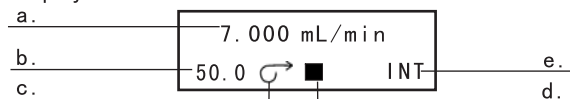



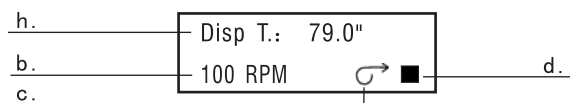
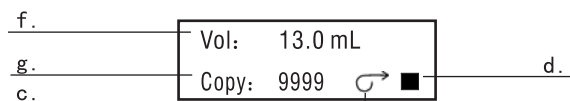





- Dispensing display: Dispensing parameters are displayed in two interfaces, Press **Exit Key** to switch these two interfaces.



- a. Current flow rates: Display current flow rates. Turn the **Knob** to increase or decrease the flow rates.
- b. Current speed: Display current speed. The speed will change when adjusting the flow rates.
- c. Running direction: Indicate the direction of the pump. ↻ Means clockwise and ↺ Means counter clockwise.
- d. Running status: ▶ means the pump is running; ■ means the pump stops; II Means pump pauses. Press **Start/Stop Key** to control the running state of the pump.
- e. Control mode: INT means the pump is controlled internally; V means the pump is controlled by external analog voltage signal; mA means the pump is controlled by external analog current signal; Hz means the pump is controlled by external 0 -10 KHz pulse signal. Off means shutting off the external control function by setting menu;
- f. Dispensing volume: Display dispensing volume in dispensing mode.
- g. Copy number: Display copy number under dispensing mode.
- h. Dispensing time: Display the dispensing time. When the dispensing procedure starts, the dispensing time will be counted down. Adjust the flow rates to change the dispensing time in dispensing parameters setting interface.

Acceptable Pump Heads and Tubing (Table 1)

	Pump Heads	Tubing (mm)	Ref. Flow Rates (mL/min)
(1, 2) × YZ1515x		13#	Single Channel 0.7-42
		14#	Single Channel 2.7-162
		19#	Single Channel 5.1-306
		16#	Single Channel 8.2-492
(1, 2) × YZII 15		25#	Single Channel 17-1020
		17#	Single Channel 29-1740
		18#	Single Channel 38-2280
(1, 2) × YZ2515x		15#	Single Channel 17-1020
		24#	Single Channel 29-1740
(1, 2) × YZII 25		15#	Single Channel 17-1020
		24#	Single Channel 29-1740
		35#	Single Channel 38-2280
		36#	Single Channel 50-3000
KZ25		15#	30-1800
		24#	58-3500
		35#	83-5000
		36#	100-6000
BZ25		24#	29-1740
DG15-24		16#	8.2-492
		25#	20-1150
		17#	30-1800
DMD25		119#	4.2-150
		120#	23-800
		15#	42-1500
		24#	68-2400
		35#	84-2950
		36#	120-4170

 Note: The running speed range of DMD25 is less than 350 rpm.

Pump heads and tubing can be selected referring to above table. It is necessary to select suitable pump heads and tubing to get higher flow rates and dispensing accuracy. We suggest the needed flow rates are in the 20% to 80% of ref. flow rates range.

Changing the Pump Head

The pump head is mounted on drive before the pump leaves the factory. Follow below procedure for changing another pump head.

1. Loose the two M4 screws which connect the pump head and the drive. Dismantle the pump head slightly.
2. Insert the flat end of the pump head's shaft to the slot of drive's coupling. Make the location hole of the pump head match the location pin of the drive.
3. Insert the two mounting screws into the mounting holes of the pump head. Then tighten the mounting screws to connecting hole of drive. (For more information, please refer to pump head's operation manual)



Note:

Turn off the power supply before changing the pump head.

Menu Diagram

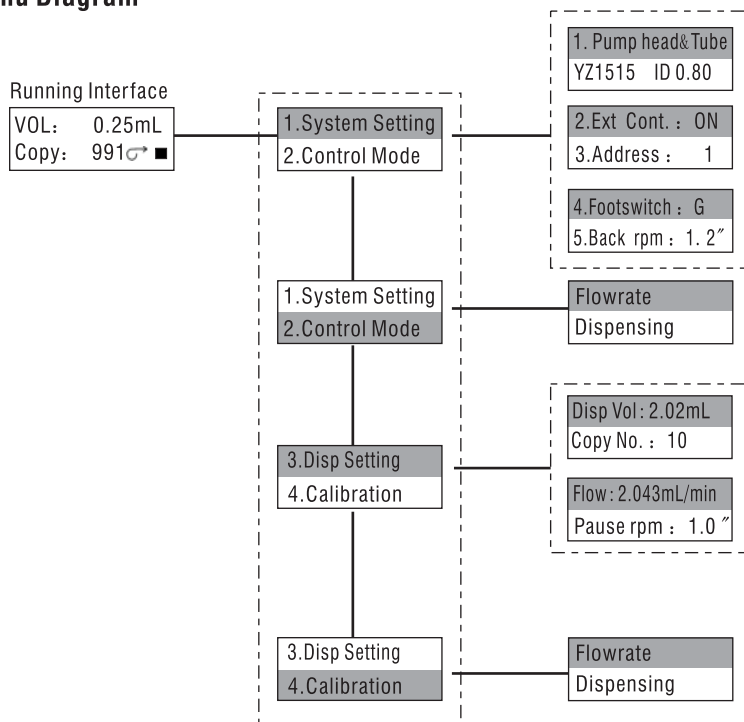

System Setting:

All the setting can not be done when pump is running.

❖ Pump head and tubing setting

Press the **Knob** to highlight Pump Head & Tube line, press **Knob** again to enter pump head selection interface, turn **Knob** to select the pump head, press the **Knob** for confirmation and enter tubing selection interface, turn **Knob** to select the tubing, press **Knob** for confirmation and return to pump head selection interface. Press **Exit Key** to return to previous menu.

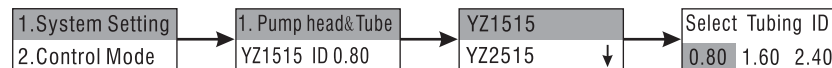

❖ External Control setting

- Set the pump to enable the external control or not.
On: Enable external control (0 - 5 V, 0 - 10 V, 4 - 20 mA, 0 - 10 KHz)
Off: Disable external control

• Set the external control

Press and turn **Knob** to highlight the external control line. Press **Knob** to enter next interface, turn **Knob** to select On or Off, press **Knob** for confirmation. Press **Exit Key** to return to previous menu.



❖ Address setting:

- When control computer controls many pumps through RS485 interface, it must identify each pump's I.D. This pump I.D. should be unique. It's the identification of this pump. Maximum 30 pieces WT600-1F can be controlled through RS485 at the same time.

• Setting the address

Press and turn **Knob** to highlight the address line. Press **Knob** again to enter next interface, turn **Knob** to select Pump I.D. number, press **Knob** for confirmation. Press **Exit Key** to return to previous menu.



❖ Footswitch Setting

- Footswitch has two kinds of working modes.

Trigger: Press footswitch, the pump starts running; Press footswitch again, the pump stops.

Gated: The pump runs as long as the footswitch is pressed.

- Set Footswitch

Press and turn **Knob** to highlight the footswitch line. Press **Knob** to enter next interface, turn **Knob** to select Trigger or Gated, press **Knob** for confirmation. Press **Exit Key** to return to previous menu.

Note:

The pump identifies the Longer Footswitch automatically. When the pump connects the footswitch, the Start/Stop Key on operating panel is invalid no matter the external control setting is on or off.



❖ Back suction rpm (revolutions per minute) Setting

- In dispensing and filling state, to prevent the liquids from dropping to cause error when the filling pauses, the pump will back-turn to suck back the liquids. The back turn angle is the same for each filling operations, it doesn't influence the filling accuracy.

- Set back suction rpm:

Press and turn **Knob** to highlight the back suction rpm line. Press **Knob** to enter next interface, turn **Knob** to select back suction rpm, press **Knob** for confirmation. Press **Exit Key** to return to previous menu.



Control Mode

- The pump has two kinds of working mode: Flow Rates and Dispensing.
- Set Control Mode:

Press and turn the **knob** to highlight control mode line. Press **Knob** to enter next interface, turn **Knob** to select control mode, press **Knob** for confirmation. Press **Exit Key** to return to previous menu.



Dispensing Setting

Before dispensing process, the parameters including pump head, tubing, back suction rpm, dispensing volume, copy number, flow rates, pause time, etc. must be set.

- ❖ Dispensing Volume: the volume that the pump dispenses between every time interval.
- Press and turn **Knob** to highlight dispensing setting line. Press **Knob** to highlight dispensing volume line. Press **Knob** again to highlight the value of the volume. Turn **Knob** to select dispensing volume, press **Knob** for confirmation. Press **Exit Key** to return to previous menu.

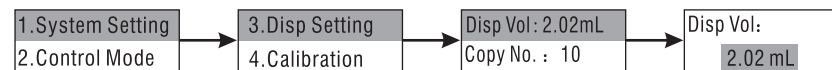

- ❖ Copy No.: the total filling number in dispensing mode. Its range is from 0 to 9999.
- Press and turn **Knob** to highlight copy number line. Press **Knob** to enter next interface. Turn **Knob** to select copy number, press **Knob** for confirmation. Press **Exit Key** to return to previous menu.
- If the copy no. is "0", the dispensing process of the pump will continue until press **Start/Stop Key** or shut off the pump to stop dispensing.



- ❖ Flow rates: Adjusting the dispensing flow rates can change the dispensing time.
 - Press and turn **Knob** to highlight dispensing flow rates line. Press **Knob** to enter next interface, turn **Knob** to select suitable flow rates, press **Knob** for confirmation. Press **Exit Key** to return to previous menu.

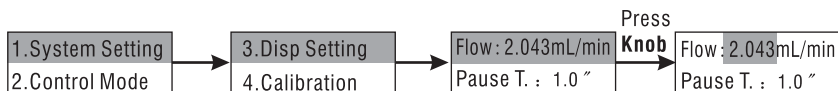

- ❖ Pause Time: Time Interval between every dispensing operation.
 - Press and turn **Knob** to highlight pause time line. Press **Knob** to enter next interface. Turn **Knob** to select pause time, press **Knob** for confirmation. Press **Exit Key** to return to previous menu.



Calibration

Pump should be calibrated when flow rates or dispense volume is beyond the tolerance. Flow rates and dispensing volume can be calibrated separately in different applications.

- ❖ Flow Rates Calibration
 - Press and turn **Knob** to highlight calibration line. Press **Knob** to enter next interface. Turn **Knob** to select Flowrate. Press **Knob** to highlight test time line. Press **Knob** again to highlight the value of time. Turn **Knob** to select test time (its range is from 30 to 1800 seconds), press **Knob** for confirmation. Press **Exit Key** to return to previous menu.
 - Press **Start/Stop Key**, the LCD displays running time and actual volume. Running time counts down.
 - Turn **Knob** to input actual test volume. Press **Knob** for confirmation. The calibration operation can be repeated.

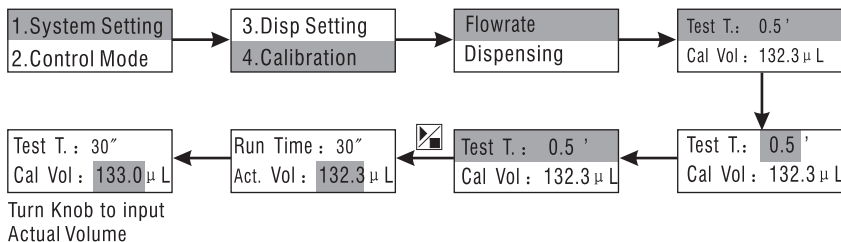

- If the actual volume is known in advance, enter the calibration interface and input the actual volume directly.

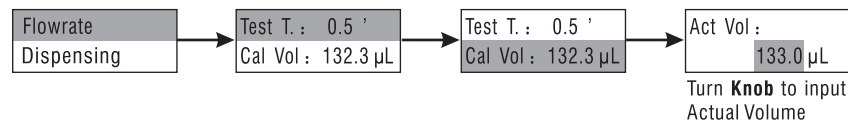

❖ Dispensing Volume Calibration

The parameters can not be changed under dispensing volume calibration operation. The defaulted parameters are the parameters set under Dispensing Setting.

- Pump stops under dispense mode, press and turn **Knob** to highlight calibration line. Press **Knob** to enter next interface. Turn **Knob** to select Dispense.
- Press **Start/Stop Key**, the LCD displays running time and actual volume. Running time counts down.
- Turn **Knob** to input actual volume. Press **Knob** for confirmation.

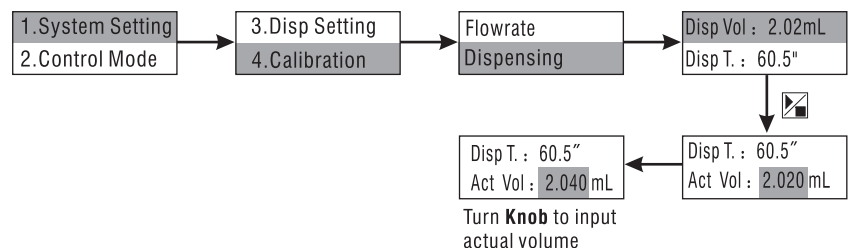

- If the actual volume is known in advance, enter the calibration interface and input the actual volume directly.

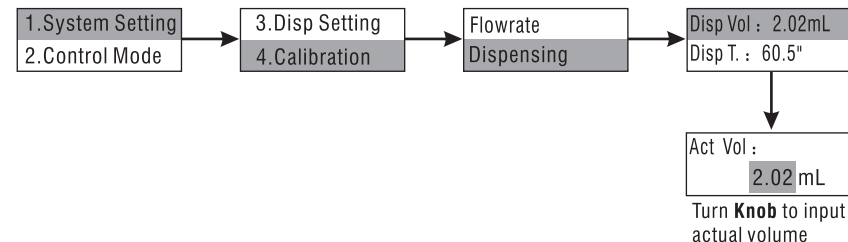

Operation Procedure

Before running the pump, select pump head and tubing refer to “Acceptable Pump Head and Tubing (Table 1)”. Thick wall tubing is preferred for longer service life.

❖ Flow rates mode operation procedure

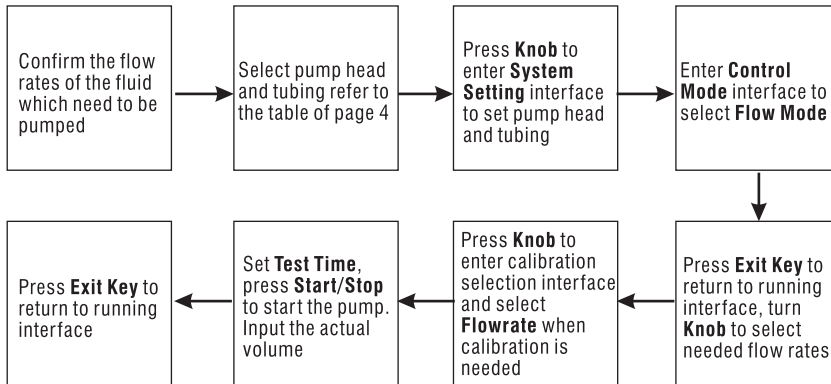

❖ Dispensing mode operation procedure

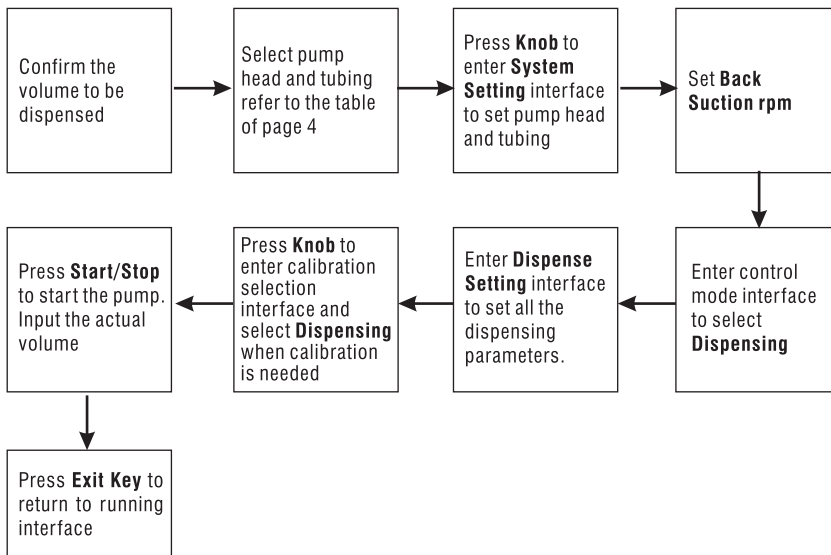

External Control Input

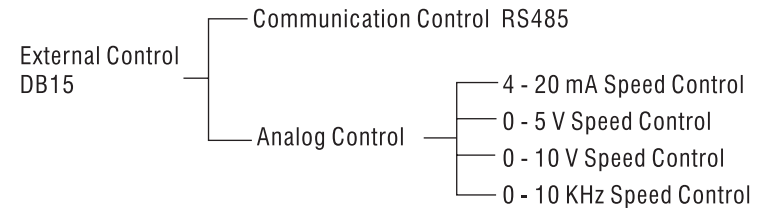

❖ Communication Control

The pump can connect to control computer (computer, PLC, SCM) through RS485 serial communication module (shown as below). Please contact Longer Company for communication protocol.

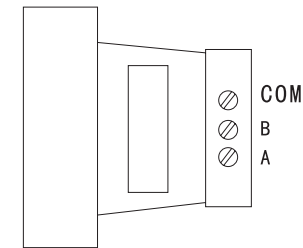

❖ Analog Signal Input function

Set the “External Control” in “on” state. External control module is shown as below.

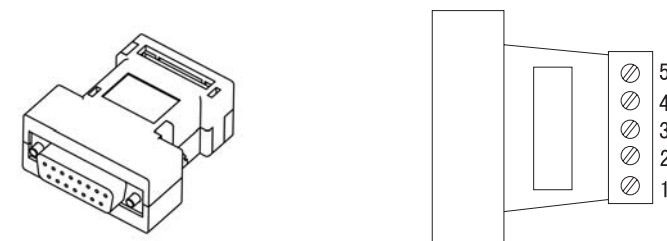

External Control Module



Note:

Five kinds of standard external control module need to be ordered separately according to special requirements.

• Terminal Definition of Standard External Control Module

- Terminal 1 Analog input in 4 - 20 mA, 0 - 5 V, 0 - 10 V external control modules. Control the speed of the pump.
- Terminal 2 External control start/stop input. When connected to COM, the pump runs; When connected to high level, the pump stops.
- Terminal 3 External control cw/ccw input. When connected to COM, the pump rotates clockwise; When connected to high level, the pump rotates counter clockwise.
- Terminal 4 Analog ground (AGND) in 4 - 20 mA, 0 - 5 V, 0 - 10 V external control modules;
Pulse input in pulse input external control modules. Control the speed of the pump. 10 KHz is corresponding to the max. speed.
- Terminal 5 The COM of external control direction and start/stop signal input; It's also the COM of pulse signal input in pulse input external control modules.

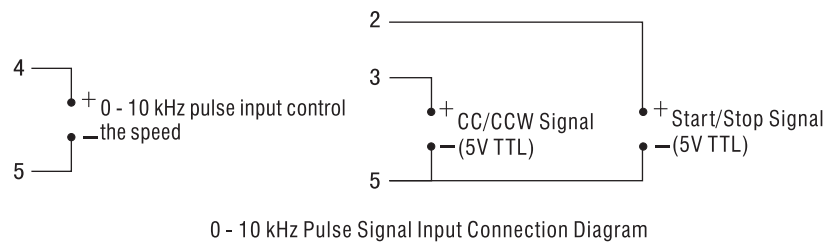
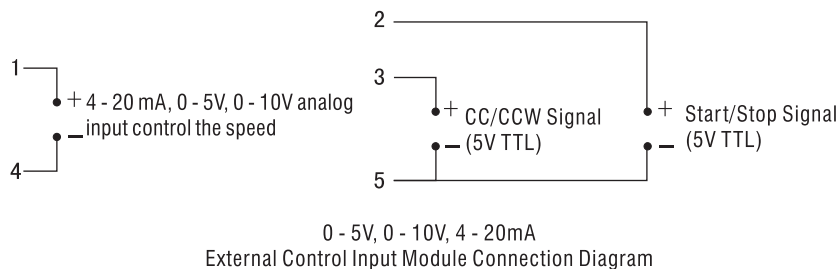

❖ External Control Output

Pump is equipped with output port in order to monitor the status of pump. Please see below "External Control Output Port Pins Diagram: DB9". Output signal adopts optoelectronic isolation circuit. A pull-up resistor and power supply are needed when using.

• Pins Definition

- Pin 1 Start/Stop output. Pump outputs low level when it runs; pump output high level when it stops.
- Pin 2 Direction output. Pump output low level when it runs clock wise; pump output high level when it runs count clock wise.
- Pin 8 Pulse output, 0 - 600 rpm corresponding to 0 - 10 kHz.
- Pin 4, 6, 7 COM

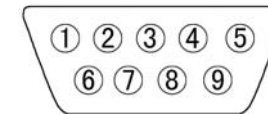

External Control Output Port Pin Diagram: DB9

Footswitch Function

Connect Footswitch to remote control Input Port to control Start/Stop of pump. It can be set according to actual application.

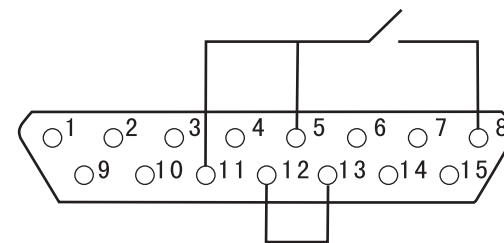

Short terminal 5 and 11; short terminal 12 and 13; terminal 8 connects footswitch; terminal 11 connects footswitch.

Connection Diagram for Footswitch



Note:

Footswitch is optional accessories. It can only control the start and stop of the pump. The speed and direction of the pump are controlled by membrane keypad and knob on the operation panel.

Communication Function

WT600-1F can connect to the control computer (computer, PLC, SCM) through RS485 serial communication interface. Max. 30 pumps can be controlled by a control computer.

Note:

1. The pump ID which connects to the control computer through RS485 serial communication interface must be unique to prevent the communication error.
2. Please contact Longer Company for communication protocol.

Maintenance

- When the pump is idle, we recommend you to release the tubing from pressure. This helps to protect the tubing from unnecessary strain and prolongs its service life
- Keep rollers clean and dry. This will prolong the service lives of tubing and pump head.
- The surface of drive and the pump head are not organic solvent and aggressive liquids resistant. Please pay attention when using.

Note :

If a trouble happens, please contact us or our dealers.

Warranty

The warranty period for this product is one year. If repair or adjustment is necessary within the warranty period, the problem will be corrected at no charge if it is not due to misuse or abuse on your part, as determined by the manufacturer. Repair costs outside the warranty period, or those resulting from product misuse or abuse, may be invoiced to you.

Technical Specifications

❖ Functions

Acceptable Pump Head: YZ1515X, YZ2515X, YZ1115, YZ1125, DG15-24, KZ25, BZ25, DMD25
Operation Mode: Membrane keypad and Knob
Direction Control: CW and CCW, reversible
Prime: Full speed for fast filling and emptying
Back Suction: Prevent the liquid from dropping
Display: 128×32 graphic LCD displays all the information
External Control Input: Control Start/Stop, direction and flow rates under flow rates mode
Footswitch: Control Start/Stop of the pump
External Control Output: Output the signals of Start/Stop, direction and speed
Communication: Communicate with control computer
Flowrate Function: Deliver fluid at set flow rates
Dispensing Function: Set dispensing volume, copy number and pause time, etc.
Memory Function: Store all the running information automatically
Calibration: Acquire higher accuracy
Cooling Mode: Heat-emitting fan

❖ Specification

Speed: 10 - 600 rpm
Flow Rates: 0.7 μL /min to 6000 mL/min
Dispensing Volume: 0.01mL to 9.99L
Copy Number: 0 to 9999 "0" means continuous running
Pause Time: 0.1s to 99.9min
Back Suction rpm: 0 to 9.9
External Control Input: Start/Stop control, direction control, flow rates control (0 - 5V , 0 - 10V , 4 - 20 mA , 0 - 10KHz optional)
External Control Output: Start/Stop, direction, 0 - 10 kHz speed signal, OC gate output
Communication Interface: RS485
Applicable Power: AC 90 - 264V 50Hz/60Hz
Power Consumption: <150W
Operating Condition: Temperature 0 to 40 °C Relative humidity < 80%
Dimension (L × W × H): 292.3 × 185 × 180.5 (mm)
Weight: 5.2 kg
IP Rating: IP 31



Baoding Longer Precision Pump Co.,Ltd.

Building A, Chuangye Center Baoding National
High - Tech Industrial Development Zone
Baoding, Hebei, China 071051
Tel: 86 - 312 - 3110087
Fax: 86 - 312 - 3168553
E - mail: longer@longerpump.com
[Http://www.longerpump.com](http://www.longerpump.com)

WT600-1F Longer Peristaltic Pump



**WT600-1F PERISTALTIC PUMP
OPERATING MANUAL**

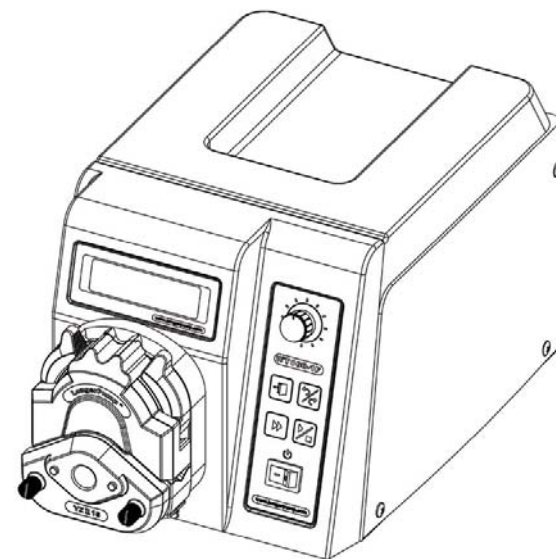

Baoding Longer Precision Pump Co.,Ltd.